

## Optocoupler, Phototransistor Output, Dual Channel

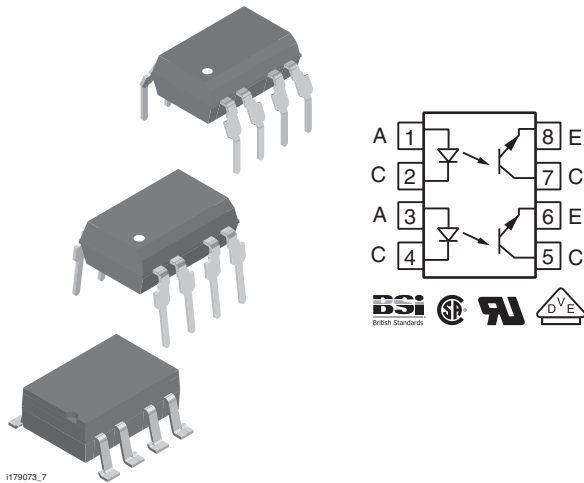

H179073\_7

### DESCRIPTION

The ILD610 series is a dual channel optocoupler series for high density applications. Each channel consists of an optically coupled pair with a gallium arsenide infrared LED and silicon NPN phototransistor. Signal information, including a DC level, can be transmitted by the device while maintaining a high degree of electrical isolation between input and output. The ILD610 series is the dual version of SFH610 series and uses a repetitive pin-out configuration instead of the more common alternating pin-out used in most dual couplers.

### FEATURES

- Dual version of SFH610 series
- Isolation test voltage, 5300 V<sub>RMS</sub>
- V<sub>CEsat</sub> 0.25 (≤ 0.4) V at I<sub>F</sub> = 10 mA, I<sub>C</sub> = 2.5 mA
- V<sub>CEO</sub> = 70 V
- Compliant to RoHS Directive 2002/95/EC and in accordance to WEEE 2002/96/EC

**RoHS**  
COMPLIANT

### AGENCY APPROVALS

- UL1577, file no. E52744 system code H or J, double protection
- DIN EN 60747-5-5 (VDE 0884)/DIN EN 60747-5-5 pending
- CSA 93751
- BSI IEC 60950; IEC 60065

### ORDERING INFORMATION

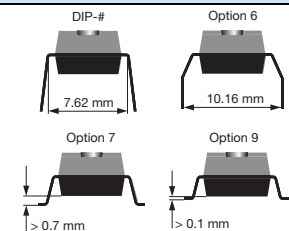
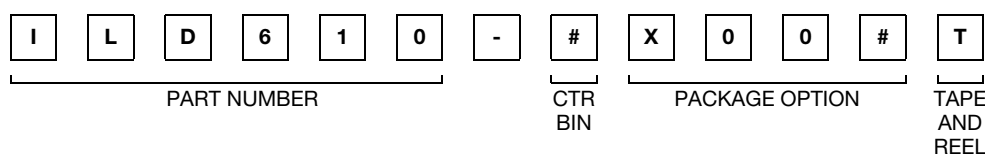

AGENCY CERTIFIED/PACKAGE	CTR (%)			
	40 to 80	63 to 125	100 to 200	160 to 320
UL, CSA, BSI	40 to 80	63 to 125	100 to 200	160 to 320
DIP-8	ILD610-1	-	ILD610-3	-
DIP-8, 400 mil, option 6	-	-	ILD610-3X006	-
SMD-8, option 7	-	ILD610-2X007T	-	-
SMD-8, option 9	-	-	ILD610-3X009	ILD610-4X009

#### Note

- Additional options may be possible, please contact sales office.

## Vishay Semiconductors Optocoupler, Phototransistor Output, Dual Channel

<b>ABSOLUTE MAXIMUM RATINGS</b> ( $T_{amb} = 25\text{ }^{\circ}\text{C}$ , unless otherwise specified)				
PARAMETER	TEST CONDITION	SYMBOL	VALUE	UNIT
<b>INPUT</b>				
Reverse voltage		$V_R$	6.0	V
Surge forward current	$t \leq 1.0\text{ ms}$	$I_{FSM}$	1.5	A
Power dissipation		$P_{diss}$	100	mW
Derate linearly from 25 °C			1.3	mW/°C
Forward continuous current		$I_F$	60	mA
<b>OUTPUT</b>				
Collector emitter voltage		$V_{CE}$	70	V
Collector current		$I_C$	50	mA
	$t \leq 1.0\text{ ms}$	$I_C$	100	mA
Power dissipation		$P_{diss}$	150	mW
Derate linearly from 25 °C			2.0	mW/°C
<b>COUPLER</b>				
Isolation test voltage	$t = 1.0\text{ s}$	$V_{ISO}$	5300	$V_{RMS}$
Isolation resistance	$V_{IO} = 500\text{ V}, T_{amb} = 25\text{ }^{\circ}\text{C}$	$R_{IO}$	$\geq 10^{12}$	$\Omega$
	$V_{IO} = 500\text{ V}, T_{amb} = 100\text{ }^{\circ}\text{C}$	$R_{IO}$	$\geq 10^{11}$	$\Omega$
Storage temperature		$T_{stg}$	- 55 to + 150	°C
Operating temperature		$T_{amb}$	- 55 to + 100	°C
Junction temperature		$T_j$	100	°C
Lead soldering time at 260 °C			10	s

### Note

- Stresses in excess of the absolute maximum ratings can cause permanent damage to the device. Functional operation of the device is not implied at these or any other conditions in excess of those given in the operational sections of this document. Exposure to absolute maximum ratings for extended periods of the time can adversely affect reliability.

<b>ELECTRICAL CHARACTERISTICS</b> ( $T_{amb} = 25\text{ }^{\circ}\text{C}$ , unless otherwise specified)							
PARAMETER	TEST CONDITION	PART	SYMBOL	MIN.	TYP.	MAX.	UNIT
<b>INPUT</b>							
Forward voltage	$I_F = 60\text{ mA}$		$V_F$		1.25	1.65	V
Reverse current	$V_R = 6.0\text{ V}$		$I_R$		0.01	10	$\mu\text{A}$
Capacitance	$V_R = 0\text{ V}, f = 1.0\text{ MHz}$		$C_O$		25		pF
<b>OUTPUT</b>							
Collector emitter breakdown voltage	$I_C = 10\text{ mA}, I_E = 10\text{ }\mu\text{A}$		$BV_{CEO}$	70	90		V
			$BV_{CEO}$	6.0	7.0		V
Collector emitter dark current	$V_{CE} = 10\text{ V}$		$I_{CEO}$		2.0	50	nA
Collector emitter capacitance	$V_{CE} = 5.0\text{ V}, f = 1.0\text{ MHz}$		$C_{CE}$		7.0		pF
Collector emitter leakage current	$V_{CE} = 10\text{ V}$	ILD610-1	$I_{CEO}$		2.0	50	nA
		ILD610-2	$I_{CEO}$		2.0	50	nA
		ILD610-3	$I_{CEO}$		5.0	100	nA
		ILD610-4	$I_{CEO}$		5.0	100	nA
<b>COUPLER</b>							
Collector emitter saturation voltage	$I_F = 10\text{ mA}, I_C = 2.5\text{ mA}$		$V_{CEsat}$		0.25	0.40	V
Coupling capacitance			$C_C$		0.35		pF

### Note

- Minimum and maximum values are testing requirements. Typical values are characteristics of the device and are the result of engineering evaluation. Typical values are for information only and are not part of the testing requirements.



Optocoupler, Phototransistor Output, Dual Channel Vishay Semiconductors

CURRENT TRANSFER RATIO ( $T_{amb} = 25\text{ }^{\circ}\text{C}$ , unless otherwise specified)							
PARAMETER	TEST CONDITION	PART	SYMBOL	MIN.	TYP.	MAX.	UNIT
CTR <sup>(1)</sup>	$I_F = 10\text{ mA}$ , $V_{CE} = 5.0\text{ V}$	ILD610-1	CTR	40		80	%
		ILD610-2	CTR	63		125	%
		ILD610-3	CTR	100		200	%
		ILD610-4	CTR	160		320	%
	$I_F = 1.0\text{ mA}$ , $V_{CE} = 5.0\text{ V}$	ILD610-1	CTR	13			%
		ILD610-2	CTR	22			%
		ILD610-3	CTR	34			%
		ILD610-4	CTR	56			%

Note

<sup>(1)</sup> CTR will match within a ratio of 1.7:1

SWITCHING CHARACTERISTICS ( $T_{amb} = 25\text{ }^{\circ}\text{C}$ , unless otherwise specified)							
PARAMETER	TEST CONDITION	PART	SYMBOL	MIN.	TYP.	MAX.	UNIT
<b>NON-SATURATED</b>							
Rise time	$V_{CC} = 5.0\text{ V}$ , $R_L = 75\text{ }\Omega$ , $I_F = 10\text{ mA}$	ILD610-1	$t_r$		2.0		$\mu\text{s}$
		ILD610-2			2.5		
		ILD610-3			2.9		
		ILD610-4			3.3		
Fall time	$V_{CC} = 5.0\text{ V}$ , $R_L = 75\text{ }\Omega$ , $I_F = 10\text{ mA}$	ILD610-1	$t_f$		2.0		$\mu\text{s}$
		ILD610-2			2.6		
		ILD610-3			3.1		
		ILD610-4			3.5		
Turn-on time	$V_{CC} = 5.0\text{ V}$ , $R_L = 75\text{ }\Omega$ , $I_F = 10\text{ mA}$	ILD610-1	$t_{on}$		3.0		$\mu\text{s}$
		ILD610-2			3.2		
		ILD610-3			3.6		
		ILD610-4			4.1		
Turn-off time	$V_{CC} = 5.0\text{ V}$ , $R_L = 75\text{ }\Omega$ , $I_F = 10\text{ mA}$	ILD610-1	$t_{off}$		2.9		$\mu\text{s}$
		ILD610-2			3.4		
		ILD610-3			3.7		
		ILD610-4			4.1		
<b>SATURATED</b>							
Rise time	$V_{CC} = 5.0\text{ V}$ , $R_L = 1.0\text{ k}\Omega$ , $I_F = 20\text{ mA}$	ILD610-1	$t_r$		2.0		$\mu\text{s}$
	$V_{CC} = 5.0\text{ V}$ , $R_L = 1.0\text{ k}\Omega$ , $I_F = 10\text{ mA}$	ILD610-2			2.8		
	$V_{CC} = 5.0\text{ V}$ , $R_L = 1.0\text{ k}\Omega$ , $I_F = 10\text{ mA}$	ILD610-3			2.8		
	$V_{CC} = 5.0\text{ V}$ , $R_L = 1.0\text{ k}\Omega$ , $I_F = 5\text{ mA}$	ILD610-4			4.6		
Fall time	$V_{CC} = 5.0\text{ V}$ , $R_L = 1.0\text{ k}\Omega$ , $I_F = 20\text{ mA}$	ILD610-1	$t_f$		11		$\mu\text{s}$
	$V_{CC} = 5.0\text{ V}$ , $R_L = 1.0\text{ k}\Omega$ , $I_F = 10\text{ mA}$	ILD610-2			14		
	$V_{CC} = 5.0\text{ V}$ , $R_L = 1.0\text{ k}\Omega$ , $I_F = 10\text{ mA}$	ILD610-3			14		
	$V_{CC} = 5.0\text{ V}$ , $R_L = 1.0\text{ k}\Omega$ , $I_F = 5\text{ mA}$	ILD610-4			15		
Turn-on time	$V_{CC} = 5.0\text{ V}$ , $R_L = 1.0\text{ k}\Omega$ , $I_F = 20\text{ mA}$	ILD610-1	$t_{on}$		3.0		$\mu\text{s}$
	$V_{CC} = 5.0\text{ V}$ , $R_L = 1.0\text{ k}\Omega$ , $I_F = 10\text{ mA}$	ILD610-2			4.3		
	$V_{CC} = 5.0\text{ V}$ , $R_L = 1.0\text{ k}\Omega$ , $I_F = 10\text{ mA}$	ILD610-3			4.3		
	$V_{CC} = 5.0\text{ V}$ , $R_L = 1.0\text{ k}\Omega$ , $I_F = 5\text{ mA}$	ILD610-4			6.0		
Turn-off time	$V_{CC} = 5.0\text{ V}$ , $R_L = 1.0\text{ k}\Omega$ , $I_F = 20\text{ mA}$	ILD610-1	$t_{off}$		18		$\mu\text{s}$
	$V_{CC} = 5.0\text{ V}$ , $R_L = 1.0\text{ k}\Omega$ , $I_F = 10\text{ mA}$	ILD610-2			25		
	$V_{CC} = 5.0\text{ V}$ , $R_L = 1.0\text{ k}\Omega$ , $I_F = 10\text{ mA}$	ILD610-3			25		
	$V_{CC} = 5.0\text{ V}$ , $R_L = 1.0\text{ k}\Omega$ , $I_F = 5\text{ mA}$	ILD610-4			25		

**TYPICAL CHARACTERISTICS** ( $T_{amb} = 25\text{ }^{\circ}\text{C}$ , unless otherwise specified)

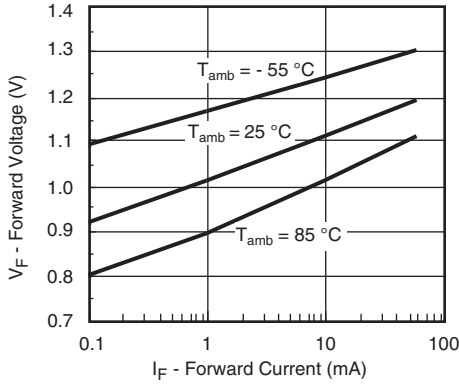

iiilct6\_01

Fig. 1 - Forward Voltage vs. Forward Current

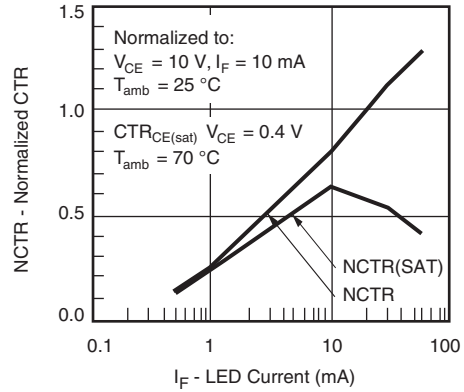

iiilct6\_04

Fig. 4 - Normalized Non-Saturated and Saturated CTR vs. LED Current

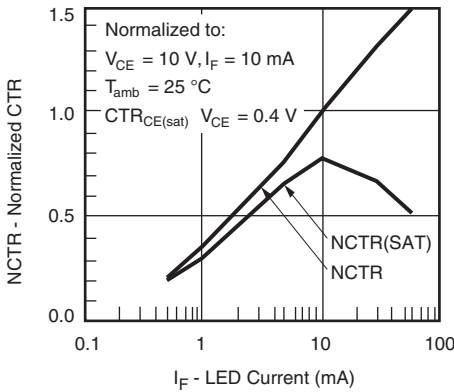

iiilct6\_02

Fig. 2 - Normalized Non-Saturated and Saturated CTR vs. LED Current

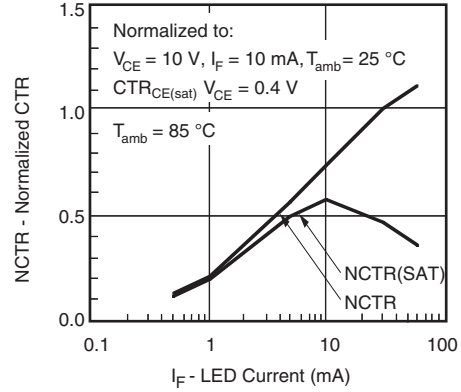

iiilct6\_05

Fig. 5 - Normalized Non-Saturated and Saturated CTR vs. LED Current

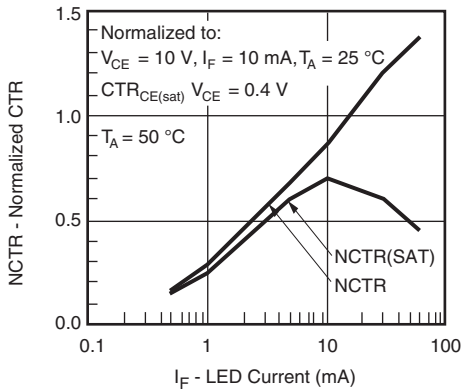

iiilct6\_03

Fig. 3 - Normalized Non-Saturated and Saturated CTR vs. LED Current

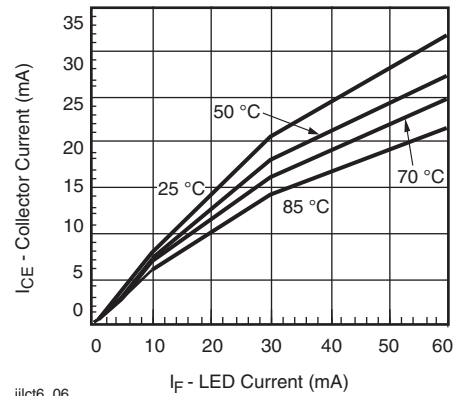

iiilct6\_06

Fig. 6 - Collector Emitter Current vs. Temperature and LED Current

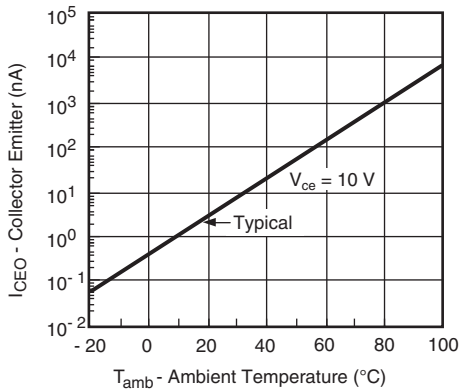

iilct6\_07

Fig. 7 - Collector Emitter Leakage Current vs. Temperature

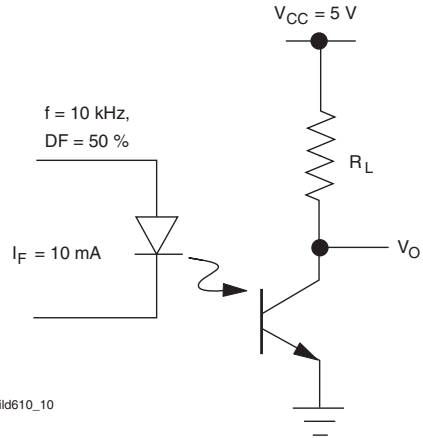

iild610\_10

Fig. 10 - Non-Saturated Switching Schematic

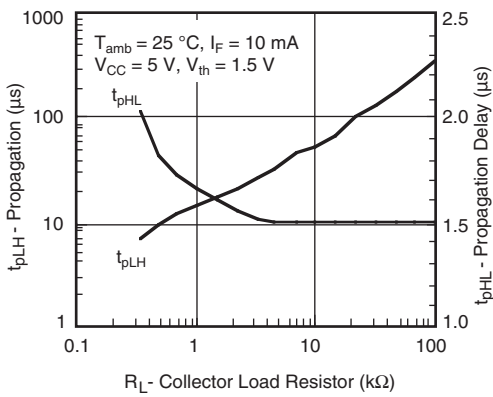

iilct6\_08

Fig. 8 - Propagation Delay vs. Collector Load Resistor

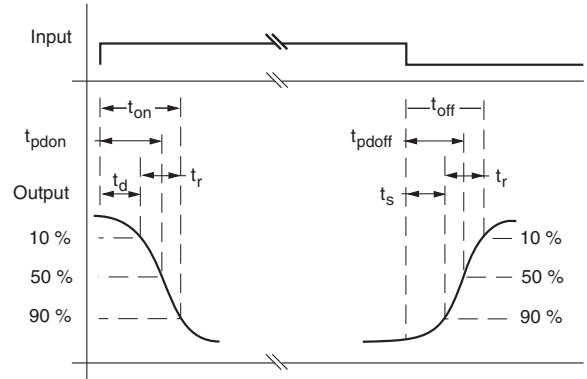

iild610\_11

Fig. 11 - Saturated Switching Time Test Waveform

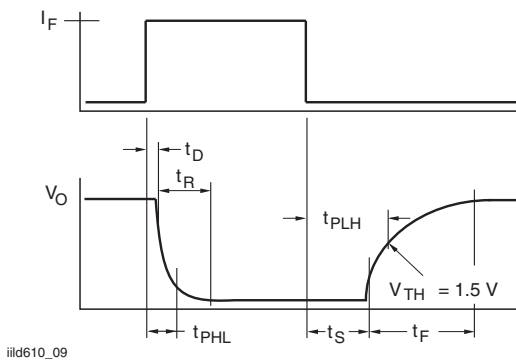

iild610\_09

Fig. 9 - Switching Timing

# ILD610

Vishay Semiconductors Optocoupler, Phototransistor Output, Dual Channel



## PACKAGE DIMENSIONS in millimeters

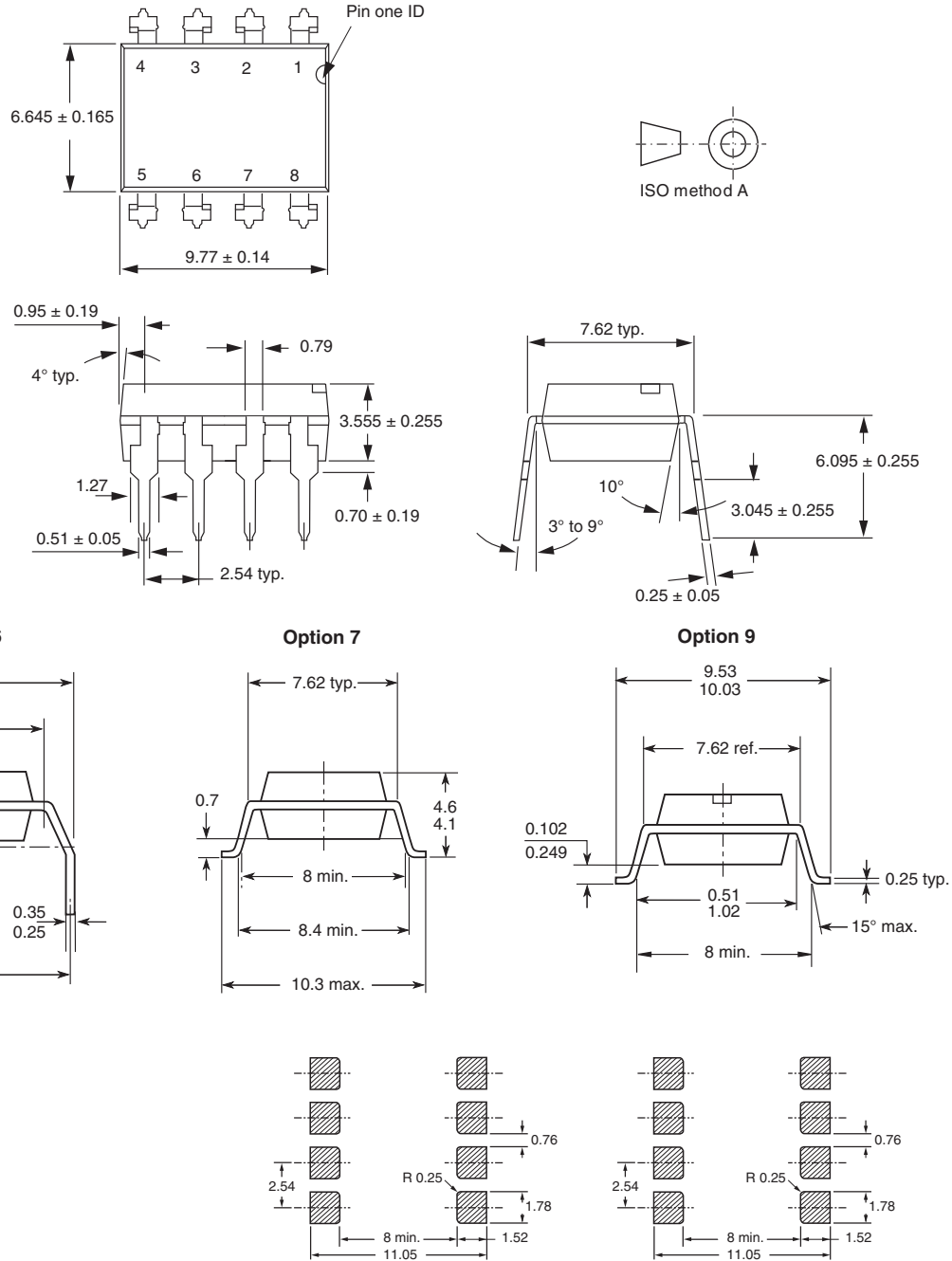

i178006

18450-6

## PACKAGE MARKING



### Notes

- Only option 1 and 7 reflected in the package marking
- Tape and reel suffix (T) is not part of the package marking



## Disclaimer

ALL PRODUCT, PRODUCT SPECIFICATIONS AND DATA ARE SUBJECT TO CHANGE WITHOUT NOTICE TO IMPROVE RELIABILITY, FUNCTION OR DESIGN OR OTHERWISE.

Vishay Intertechnology, Inc., its affiliates, agents, and employees, and all persons acting on its or their behalf (collectively, "Vishay"), disclaim any and all liability for any errors, inaccuracies or incompleteness contained in any datasheet or in any other disclosure relating to any product.

Vishay makes no warranty, representation or guarantee regarding the suitability of the products for any particular purpose or the continuing production of any product. To the maximum extent permitted by applicable law, Vishay disclaims (i) any and all liability arising out of the application or use of any product, (ii) any and all liability, including without limitation special, consequential or incidental damages, and (iii) any and all implied warranties, including warranties of fitness for particular purpose, non-infringement and merchantability.

Statements regarding the suitability of products for certain types of applications are based on Vishay's knowledge of typical requirements that are often placed on Vishay products in generic applications. Such statements are not binding statements about the suitability of products for a particular application. It is the customer's responsibility to validate that a particular product with the properties described in the product specification is suitable for use in a particular application. Parameters provided in datasheets and / or specifications may vary in different applications and performance may vary over time. All operating parameters, including typical parameters, must be validated for each customer application by the customer's technical experts. Product specifications do not expand or otherwise modify Vishay's terms and conditions of purchase, including but not limited to the warranty expressed therein.

Hyperlinks included in this datasheet may direct users to third-party websites. These links are provided as a convenience and for informational purposes only. Inclusion of these hyperlinks does not constitute an endorsement or an approval by Vishay of any of the products, services or opinions of the corporation, organization or individual associated with the third-party website. Vishay disclaims any and all liability and bears no responsibility for the accuracy, legality or content of the third-party website or for that of subsequent links.

Except as expressly indicated in writing, Vishay products are not designed for use in medical, life-saving, or life-sustaining applications or for any other application in which the failure of the Vishay product could result in personal injury or death. Customers using or selling Vishay products not expressly indicated for use in such applications do so at their own risk. Please contact authorized Vishay personnel to obtain written terms and conditions regarding products designed for such applications.

No license, express or implied, by estoppel or otherwise, to any intellectual property rights is granted by this document or by any conduct of Vishay. Product names and markings noted herein may be trademarks of their respective owners.