

NTMFS4108N

Power MOSFET

30 V, 35 A, Single N-Channel,
SO-8 Flat Lead Package

Features

- Thermally and Electrically Enhanced Packaging Compatible with Standard SO-8 Package Footprint
- New Package Provides Capability of Inspection and Probe After Board Mounting
- Ultra Low $R_{DS(on)}$ (at 4.5 V_{GS}), Low Gate Resistance and Low Q_G
- Optimized for Low Side Synchronous Applications
- High Speed Switching Capability
- These are Pb-Free Devices

Applications

- Notebook Computer V_{core} Applications
- Network Applications
- DC-DC Converters

MAXIMUM RATINGS (T_J = 25°C unless otherwise noted)

Rating			Symbol	Value	Unit
Drain-to-Source Voltage			V _{DSS}	30	V
Gate-to-Source Voltage			V _{GS}	±20	V
Continuous Drain Current (Note 1)	Steady State	T _A = 25°C	I _D	22	A
		T _A = 85°C		16	
	t ≤ 10 s	T _A = 25°C		35	
Power Dissipation (Note 1)	Steady State	T _A = 25°C	P _D	2.7	W
	t ≤ 10 s			7.2	
Continuous Drain Current (Note 2)	Steady State	T _A = 25°C	I _D	13.5	A
		T _A = 85°C		10	
Power Dissipation (Note 2)	Steady State	T _A = 25°C	P _D	1.1	W
Power Dissipation R _{θJC} (Note 1)		T _C = 25°C		P _D	
Pulsed Drain Current	t _p = 10 μs		I _{DM}	288	A
Operating Junction and Storage Temperature			T _J , T _{stg}	-55 to 150	°C
Continuous Source Current (Body Diode)			I _S	6.0	A
Single Pulse Drain-to-Source Avalanche Energy (V _{DD} = 30 V, V _{GS} = 10 V, I _{PK} = 30 A, L = 1 mH, R _G = 25 Ω)			E _{AS}	450	mJ
Lead Temperature for Soldering Purposes (1/8" from case for 10 s)			T _L	260	°C

Stresses exceeding Maximum Ratings may damage the device. Maximum Ratings are stress ratings only. Functional operation above the Recommended Operating Conditions is not implied. Extended exposure to stresses above the Recommended Operating Conditions may affect device reliability.

1. Surface-mounted on FR4 board using 1" sq. pad size (Cu area = 650 mm² [1 oz] including traces).
2. Surface-mounted on FR4 board using the minimum recommended pad size (Cu area = 50 mm²).



ON Semiconductor®

<http://onsemi.com>

V _{(BR)DSS}	R _{DS(on)} TYP	I _D MAX
30 V	1.8 mΩ @ 10 V	35 A
	2.7 mΩ @ 4.5 V	

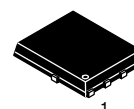
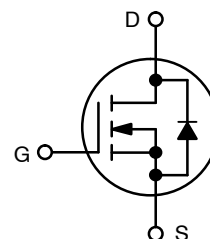

SO-8 FLAT LEAD
CASE 488AA
STYLE 1

MARKING DIAGRAM

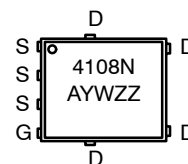

4108N = Specific Device Code
A = Assembly Location
Y = Year
W = Work Week
ZZ = Lot Traceability

ORDERING INFORMATION

Device	Package	Shipping†
NTMFS4108NT1G	SO-8 FL (Pb-Free)	1500 Tape / Reel
NTMFS4108NT3G	SO-8 FL (Pb-Free)	5000 Tape / Reel

†For information on tape and reel specifications, including part orientation and tape sizes, please refer to our Tape and Reel Packaging Specification Brochure, BRD8011/D.

NTMFS4108N

THERMAL RESISTANCE RATINGS

Rating	Symbol	Max	Unit
Junction-to-Case (Drain Terminal)	$R_{\theta JC}$	1.3	°C/W
Junction-to-Ambient - Steady State (Note 3)	$R_{\theta JA}$	45.7	
Junction-to-Ambient - $t \leq 10$ s (Note 3)	$R_{\theta JA}$	17.3	
Junction-to-Ambient - Steady State (Note 4)	$R_{\theta JA}$	117	

ELECTRICAL CHARACTERISTICS ($T_J = 25^\circ\text{C}$ unless otherwise noted)

Characteristic	Symbol	Test Condition	Min	Typ	Max	Unit
----------------	--------	----------------	-----	-----	-----	------

OFF CHARACTERISTICS

Drain-to-Source Breakdown Voltage	$V_{(BR)DSS}$	$V_{GS} = 0$ V, $I_D = 250$ μ A	30			V
Drain-to-Source Breakdown Voltage Temperature Coefficient	$V_{(BR)DSS}/T_J$			21		mV/°C
Zero Gate Voltage Drain Current	I_{DSS}	$V_{GS} = 0$ V, $V_{DS} = 24$ V	$T_J = 25^\circ\text{C}$		1.0	μ A
			$T_J = 125^\circ\text{C}$		25	
Gate-to-Source Leakage Current	I_{GSS}	$V_{DS} = 0$ V, $V_{GS} = 20$ V			100	nA

ON CHARACTERISTICS (Note 5)

Gate Threshold Voltage	$V_{GS(TH)}$	$V_{GS} = V_{DS}$, $I_D = 250$ μ A	1.0		2.5	V
Negative Threshold Temperature Coefficient	$V_{GS(TH)}/T_J$			7.5		mV/°C
Drain-to-Source On Resistance	$R_{DS(on)}$	$V_{GS} = 4.5$ V, $I_D = 19$ A		2.7	3.4	m Ω
		$V_{GS} = 10$ V, $I_D = 21$ A		1.8	2.2	
Forward Transconductance	g_{FS}	$V_{DS} = 15$ V, $I_D = 10$ A		25		S

CHARGES, CAPACITANCES AND GATE RESISTANCE

Input Capacitance	C_{ISS}	$V_{GS} = 0$ V, $f = 1.0$ MHz, $V_{DS} = 15$ V		6000		pF
Output Capacitance	C_{OSS}			1200		
Reverse Transfer Capacitance	C_{RSS}			700		
Total Gate Charge	$Q_{G(TOT)}$	$V_{GS} = 4.5$ V, $V_{DS} = 24$ V, $I_D = 21$ A		54		nC
Threshold Gate Charge	$Q_{G(TH)}$			11		
Gate-to-Source Charge	Q_{GS}			16		
Gate-to-Drain Charge	Q_{GD}			23		
Gate Resistance	R_G			0.7		

SWITCHING CHARACTERISTICS, $V_{GS} = 10$ V (Note 6)

Turn-On Delay Time	$t_{d(ON)}$	$V_{GS} = 4.5$ V, $V_{DS} = 15$ V, $I_D = 1.0$ A, $R_G = 6.0$ Ω		45		ns
Rise Time	t_r			60		
Turn-Off Delay Time	$t_{d(OFF)}$			70		
Fall Time	t_f			140		

DRAIN-SOURCE DIODE CHARACTERISTICS

Forward Diode Voltage	V_{SD}	$V_{GS} = 0$ V, $I_S = 6.0$ A	$T_J = 25^\circ\text{C}$		0.72	1.1	V
			$T_J = 125^\circ\text{C}$		0.65		
Reverse Recovery Time	t_{RR}	$V_{GS} = 0$ V, $dI_S/dt = 100$ A/ μ s, $I_S = 6.0$ A		41		ns	
Charge Time	t_a			20			
Discharge Time	t_b			21			
Reverse Recovery Charge	Q_{RR}			45			nC

- Surface-mounted on FR4 board using 1" sq. pad size (Cu area = 650 mm² [1 oz] including traces).
- Surface-mounted on FR4 board using the minimum recommended pad size (Cu area = 50 mm²).
- Pulse Test: Pulse Width ≤ 300 μ s, Duty Cycle $\leq 2\%$.
- Switching characteristics are independent of operating junction temperatures.

TYPICAL PERFORMANCE CURVES

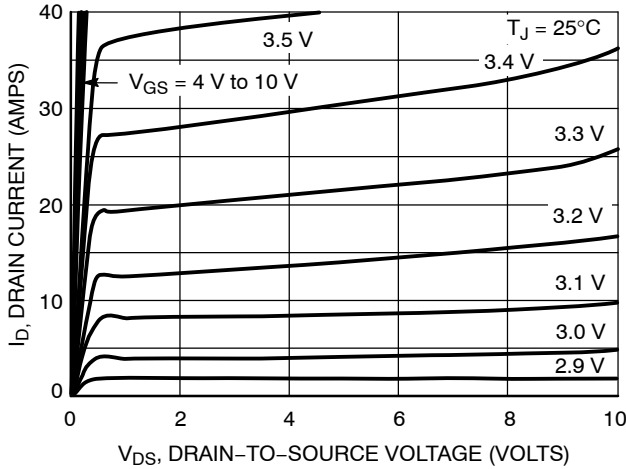

Figure 1. On-Region Characteristics

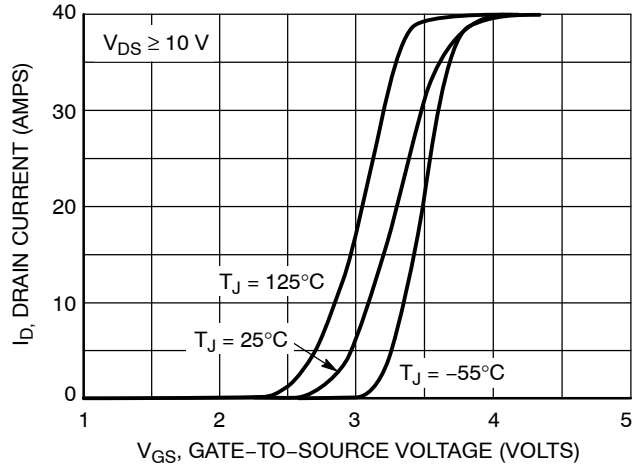

Figure 2. Transfer Characteristics

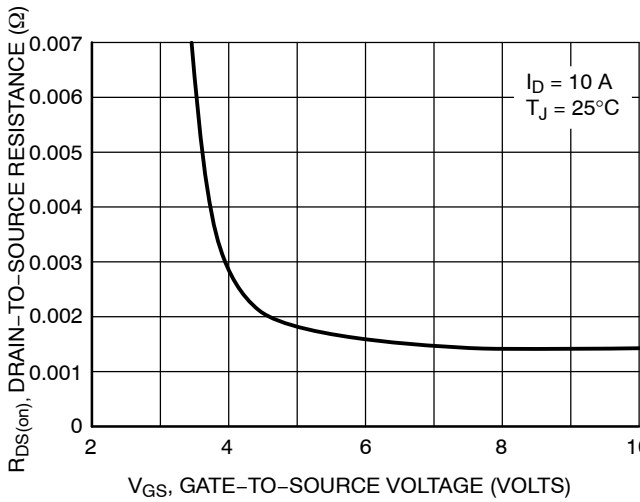

Figure 3. On-Resistance vs. Gate-to-Source Voltage

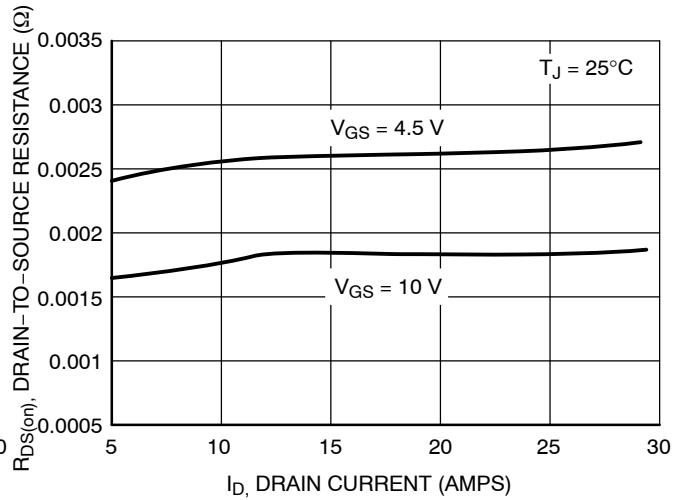

Figure 4. On-Resistance vs. Drain Current and Gate Voltage

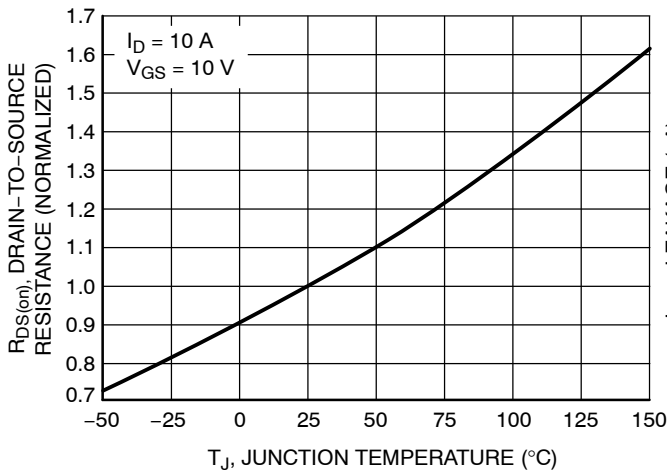

Figure 5. On-Resistance Variation with Temperature

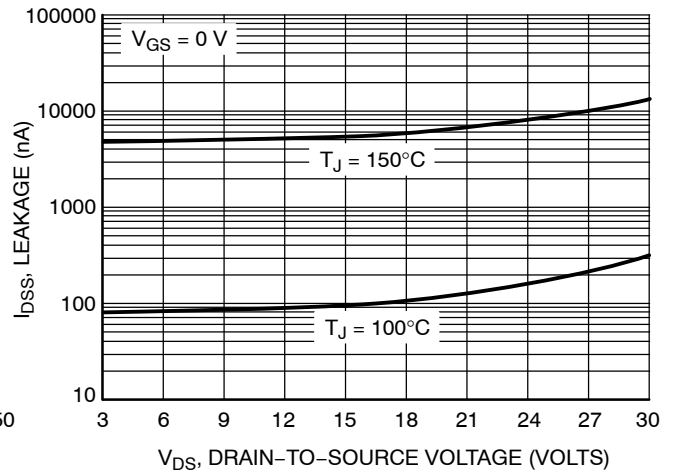

Figure 6. Drain-to-Source Leakage Current vs. Voltage

TYPICAL PERFORMANCE CURVES

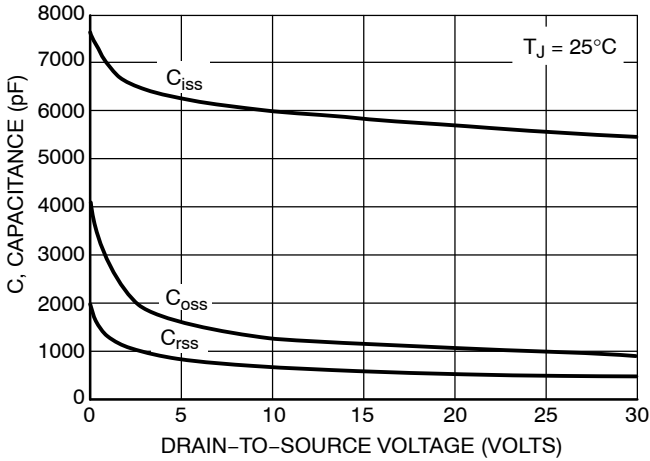

Figure 7. Capacitance Variation

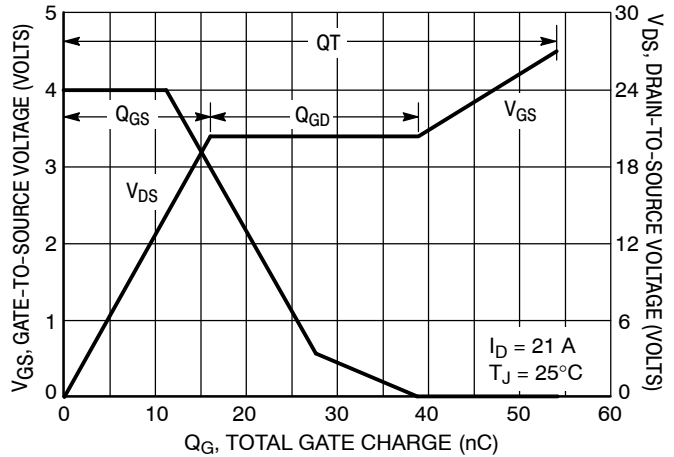

Figure 8. Gate-To-Source and Drain-To-Source Voltage vs. Total Charge

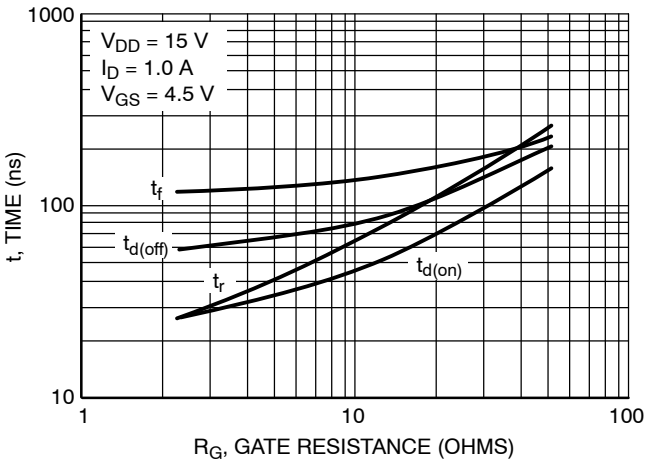

Figure 9. Resistive Switching Time Variation vs. Gate Resistance

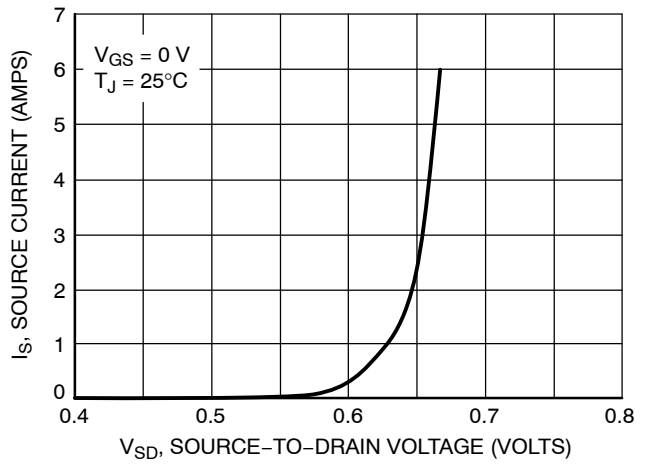

Figure 10. Diode Forward Voltage vs. Current

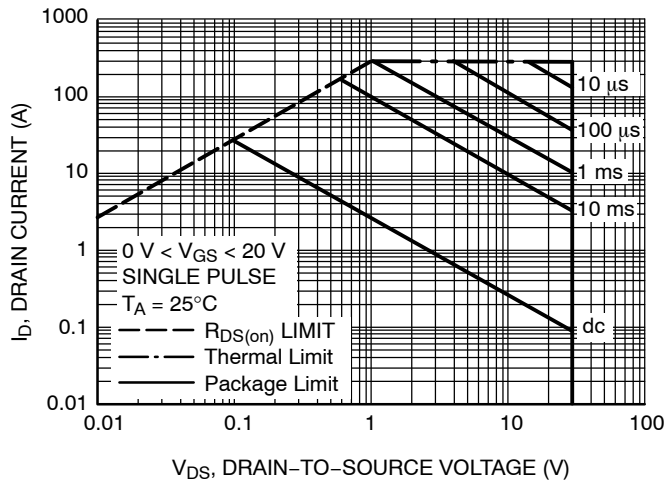

Figure 11. Maximum Rated Forward Biased Safe Operating Area

NTMFS4108N

TYPICAL PERFORMANCE CURVES

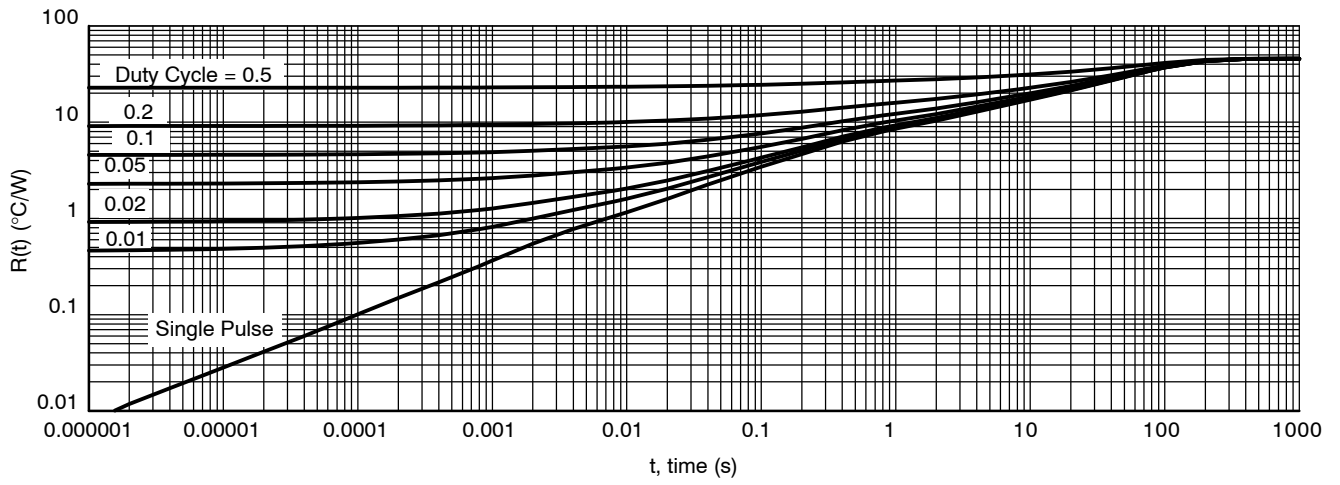
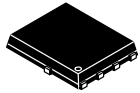

Figure 12. FET Thermal Response

MECHANICAL CASE OUTLINE

PACKAGE DIMENSIONS



1
SCALE 2:1

DFN5 5x6, 1.27P
(SO-8FL)
CASE 488AA
ISSUE N

DATE 25 JUN 2018

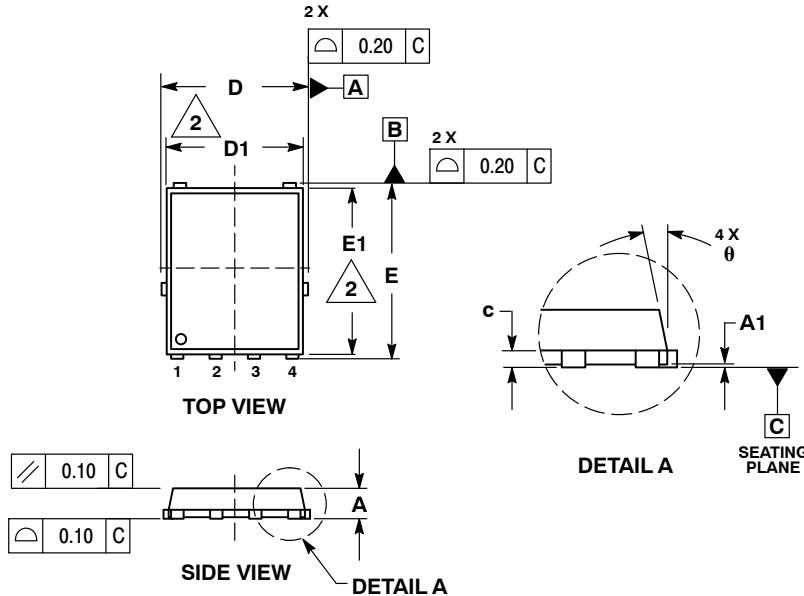

NOTES:

1. DIMENSIONING AND TOLERANCING PER ASME Y14.5M, 1994.
2. CONTROLLING DIMENSION: MILLIMETER.
3. DIMENSION D1 AND E1 DO NOT INCLUDE MOLD FLASH PROTRUSIONS OR GATE BURRS.

DIM	MILLIMETERS		
	MIN	NOM	MAX
A	0.90	1.00	1.10
A1	0.00	---	0.05
b	0.33	0.41	0.51
c	0.23	0.28	0.33
D	5.00	5.15	5.30
D1	4.70	4.90	5.10
D2	3.80	4.00	4.20
E	6.00	6.15	6.30
E1	5.70	5.90	6.10
E2	3.45	3.65	3.85
e	1.27 BSC		
G	0.51	0.575	0.71
K	1.20	1.35	1.50
L	0.51	0.575	0.71
L1	0.125 REF		
M	3.00	3.40	3.80
θ	0°	---	12°

GENERIC MARKING DIAGRAM*

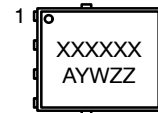

- XXXXXX = Specific Device Code
- A = Assembly Location
- Y = Year
- W = Work Week
- ZZ = Lot Traceability

*This information is generic. Please refer to device data sheet for actual part marking. Pb-Free indicator, "G" or microdot "•", may or may not be present. Some products may not follow the Generic Marking.

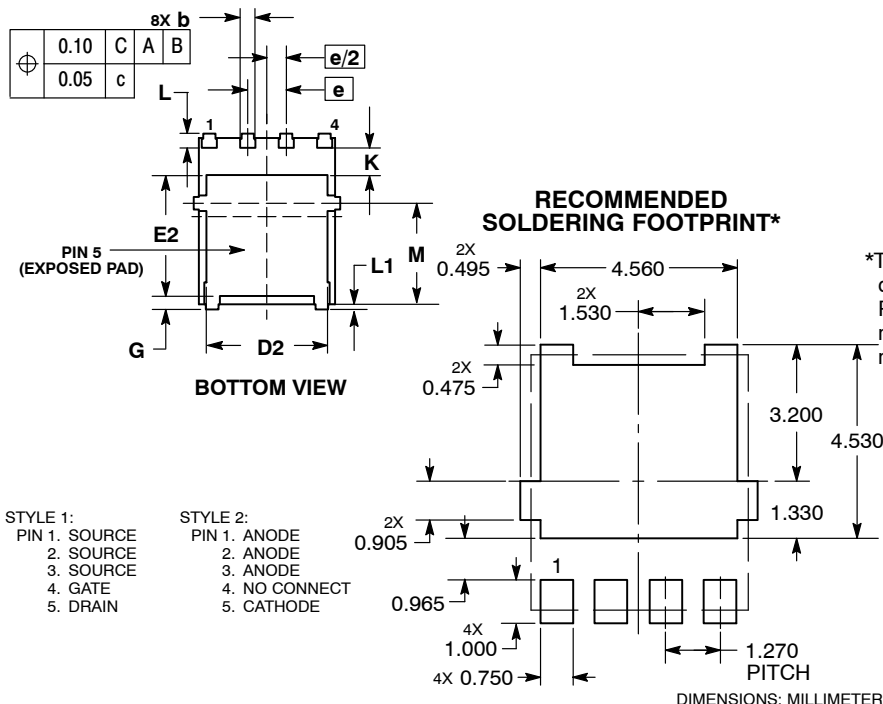

- STYLE 1:
PIN 1. SOURCE
2. SOURCE
3. SOURCE
4. GATE
5. DRAIN
- STYLE 2:
PIN 1. ANODE
2. ANODE
3. ANODE
4. NO CONNECT
5. CATHODE

DIMENSIONS: MILLIMETERS

*For additional information on our Pb-Free strategy and soldering details, please download the ON Semiconductor Soldering and Mounting Techniques Reference Manual, SOLDERRM/D.

DOCUMENT NUMBER:	98AON14036D	Electronic versions are uncontrolled except when accessed directly from the Document Repository. Printed versions are uncontrolled except when stamped "CONTROLLED COPY" in red.
DESCRIPTION:	DFN5 5x6, 1.27P (SO-8FL)	PAGE 1 OF 1

onsemi and ONSEMI are trademarks of Semiconductor Components Industries, LLC dba onsemi or its subsidiaries in the United States and/or other countries. onsemi reserves the right to make changes without further notice to any products herein. onsemi makes no warranty, representation or guarantee regarding the suitability of its products for any particular purpose, nor does onsemi assume any liability arising out of the application or use of any product or circuit, and specifically disclaims any and all liability, including without limitation special, consequential or incidental damages. onsemi does not convey any license under its patent rights nor the rights of others.

onsemi, **Onsemi**, and other names, marks, and brands are registered and/or common law trademarks of Semiconductor Components Industries, LLC dba "**onsemi**" or its affiliates and/or subsidiaries in the United States and/or other countries. **onsemi** owns the rights to a number of patents, trademarks, copyrights, trade secrets, and other intellectual property. A listing of **onsemi**'s product/patent coverage may be accessed at www.onsemi.com/site/pdf/Patent-Marking.pdf. **onsemi** reserves the right to make changes at any time to any products or information herein, without notice. The information herein is provided "as-is" and **onsemi** makes no warranty, representation or guarantee regarding the accuracy of the information, product features, availability, functionality, or suitability of its products for any particular purpose, nor does **onsemi** assume any liability arising out of the application or use of any product or circuit, and specifically disclaims any and all liability, including without limitation special, consequential or incidental damages. Buyer is responsible for its products and applications using **onsemi** products, including compliance with all laws, regulations and safety requirements or standards, regardless of any support or applications information provided by **onsemi**. "Typical" parameters which may be provided in **onsemi** data sheets and/or specifications can and do vary in different applications and actual performance may vary over time. All operating parameters, including "Typicals" must be validated for each customer application by customer's technical experts. **onsemi** does not convey any license under any of its intellectual property rights nor the rights of others. **onsemi** products are not designed, intended, or authorized for use as a critical component in life support systems or any FDA Class 3 medical devices or medical devices with a same or similar classification in a foreign jurisdiction or any devices intended for implantation in the human body. Should Buyer purchase or use **onsemi** products for any such unintended or unauthorized application, Buyer shall indemnify and hold **onsemi** and its officers, employees, subsidiaries, affiliates, and distributors harmless against all claims, costs, damages, and expenses, and reasonable attorney fees arising out of, directly or indirectly, any claim of personal injury or death associated with such unintended or unauthorized use, even if such claim alleges that **onsemi** was negligent regarding the design or manufacture of the part. **onsemi** is an Equal Opportunity/Affirmative Action Employer. This literature is subject to all applicable copyright laws and is not for resale in any manner.

ADDITIONAL INFORMATION

TECHNICAL PUBLICATIONS:

Technical Library: www.onsemi.com/design/resources/technical-documentation
onsemi Website: www.onsemi.com

ONLINE SUPPORT: www.onsemi.com/support

For additional information, please contact your local Sales Representative at www.onsemi.com/support/sales