



FAST RECOVERY RECTIFIER DIODES

MAIN PRODUCT CHARACTERISTICS

$I_{F(AV)}$	16 A
V_{RRM}	400 V
$V_F(\max)$	1.4 V
$t_{rr}(\max)$	35 ns

FEATURES AND BENEFITS

- VERY LOW REVERSE RECOVERY TIME
- VERY LOW SWITCHING LOSSES
- LOW NOISE TURN-OFF SWITCHING

DESCRIPTION

This double rectifier is suited for Switch Mode Power Supplies and other power converters.

This device is intended to free-wheeling function in converters and motor control circuits.

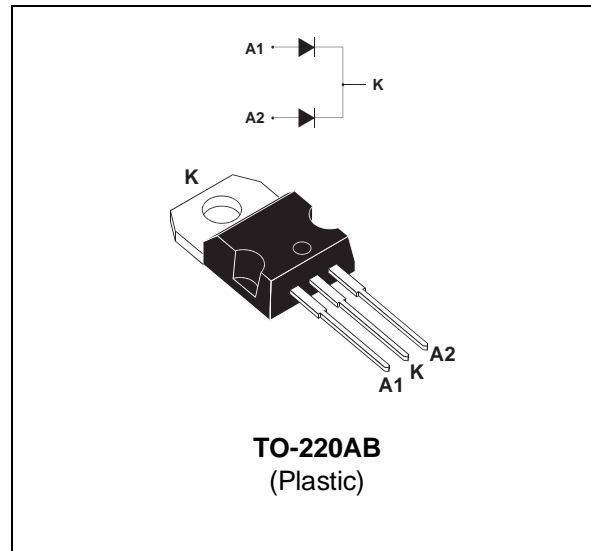

ABSOLUTE RATINGS (limiting values, per diode)

Symbol	Parameter	Value	Unit
V_{RRM}	Repetitive peak reverse voltage	400	V
I_{FRM}	Repetitive peak forward current	$t_p=5 \mu s$ $F=1kHz$	A
$I_{F(RMS)}$	RMS forward current	30	A
$I_{F(AV)}$	Average forward current	$T_c = 100^\circ C$ $\delta = 0.5$	A
I_{FSM}	Surge non repetitive forward current	$t_p = 10 ms$ Sinusoidal	A
T_{stg}	Storage temperature range	- 40 to + 150	$^\circ C$
T_j	Maximum operating junction temperature	150	$^\circ C$

BYT16P-400

THERMAL RESISTANCES

Symbol	Parameter		Value	Unit
$R_{th(j-c)}$	Junction to case	Per diode	3.75	°C/W
		Total	2	
$R_{th(c)}$		Coupling	0.25	

When the diodes 1 and 2 are used simultaneously:

$$\Delta T_{j(\text{diode } 1)} = P(\text{diode } 1) \times R_{th(j-c)} (\text{Per diode}) + P(\text{diode } 2) \times R_{th(c)}$$

STATIC ELECTRICAL CHARACTERISTICS

Symbol	Parameter	Test Conditions		Min.	Typ.	Max.	Unit
V_F^*	Forward voltage drop	$T_j = 25^\circ\text{C}$	$I_F = 8\text{ A}$			1.5	V
		$T_j = 100^\circ\text{C}$				1.4	
I_R^{**}	Reverse leakage current	$T_j = 25^\circ\text{C}$	$V_R = V_{RRM}$			15	μA
		$T_j = 100^\circ\text{C}$				2.5	mA

Pulse test : * $t_p = 380\ \mu\text{s}$, $\delta < 2\%$

** $t_p = 5\ \text{ms}$, $\delta < 2\%$

To evaluate the conduction losses use the following equation:

$$P = 1.1 \times I_{F(AV)} + 0.024 I_{F(RMS)}^2$$

RECOVERY CHARACTERISTICS

Symbol	Test Conditions		Min.	Typ.	Max.	Unit
t_{rr}	$T_j = 25^\circ\text{C}$	$I_F = 1\text{ A}$ $V_R = 30\text{ V}$ $dI_F/dt = -15\text{ A}/\mu\text{s}$			75	ns
		$I_F = 0.5\text{ A}$ $I_R = 1\text{ A}$ $I_{rr} = 0.25\text{ A}$			35	

TURN-OFF SWITCHING CHARACTERISTICS

Symbol	Parameter	Test Conditions		Min.	Typ.	Max.	Unit
t_{IRM}	Maximum reverse recovery time	$dI_F/dt = -32\text{ A}/\mu\text{s}$	$V_{CC} = 200\text{ V}$ $I_F = 8\text{ A}$ $L_p \leq 0.05\ \mu\text{H}$ $T_j = 100^\circ\text{C}$ (see fig. 11)			75	ns
		$dI_F/dt = -64\text{ A}/\mu\text{s}$				50	
I_{RM}	Maximum reverse recovery current	$dI_F/dt = -32\text{ A}/\mu\text{s}$	$V_{CC} = 200\text{ V}$ $I_F = 8\text{ A}$ $L_p \leq 0.05\ \mu\text{H}$ $T_j = 100^\circ\text{C}$ (see fig. 11)			2.2	A
		$dI_F/dt = -64\text{ A}/\mu\text{s}$				2.8	
$C = \frac{V_{RP}}{V_{CC}}$	Turn-off overvoltage coefficient	$T_j = 100^\circ\text{C}$	$V_{CC} = 120\text{ V}$ $I_F = I_{F(AV)}$ $dI_F/dt = -8\text{ A}/\mu\text{s}$ (see fig. 12)			3.3	/

Fig. 1: Low frequency power losses versus average current.

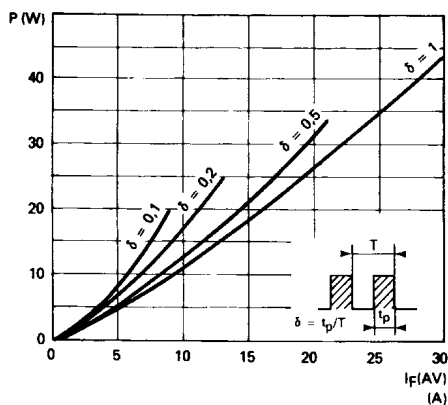

Fig. 2: Peak current versus form factor.

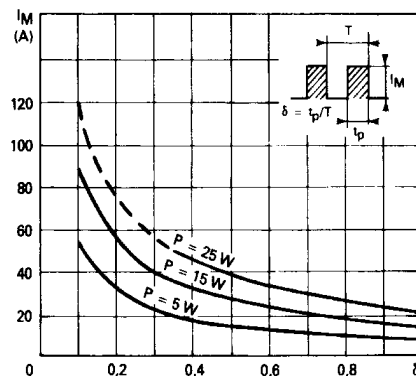

Fig. 3: Non repetitive peak surge current versus overload duration.

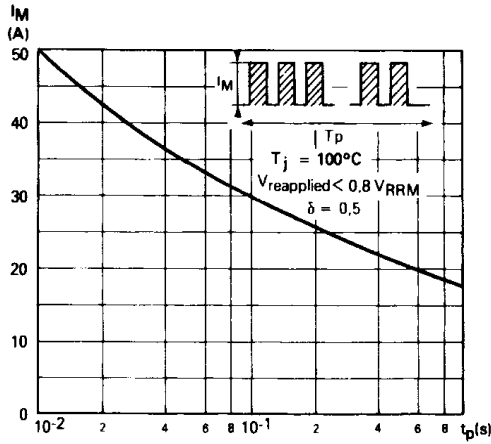

Fig. 4: Thermal impedance versus pulse width.

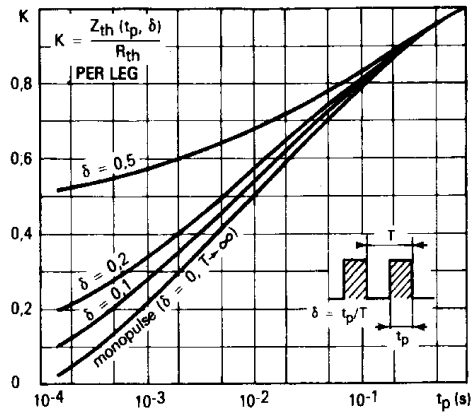

Fig. 5: Voltage drop versus forward current.

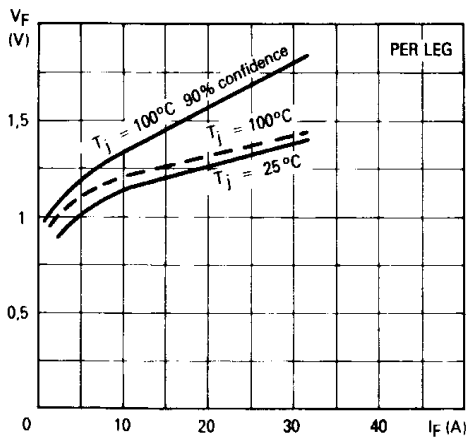

Fig. 6: Recovery charge versus di_F/dt.

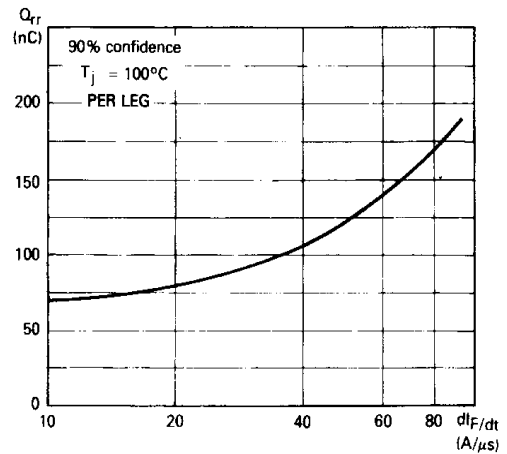

Fig. 7: Recovery time versus di_F/dt.

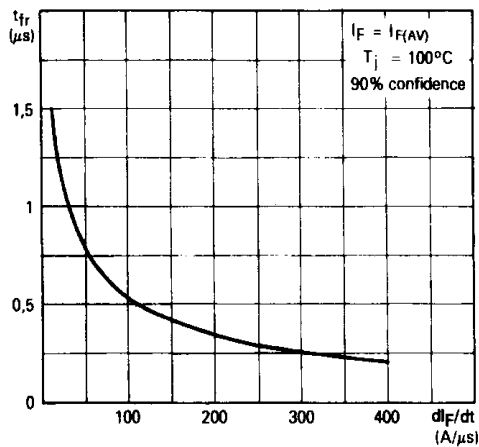

Fig. 8: Peak reverse current versus di_F/dt.

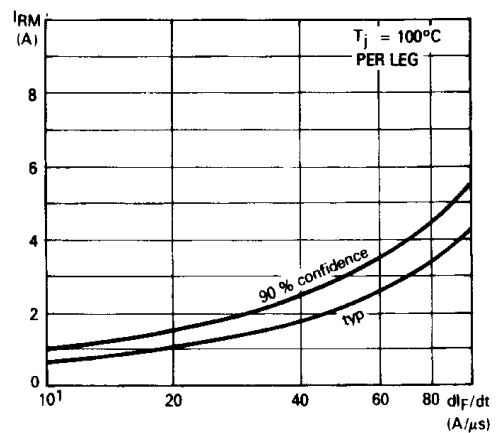

Fig. 9: Peak forward voltage versus di_F/dt .

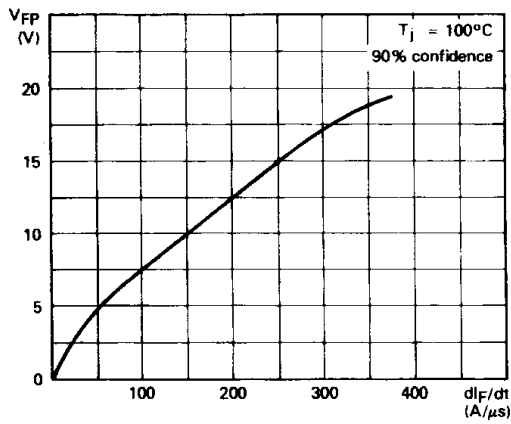

Fig. 10: Dynamic parameters versus junction temperature.

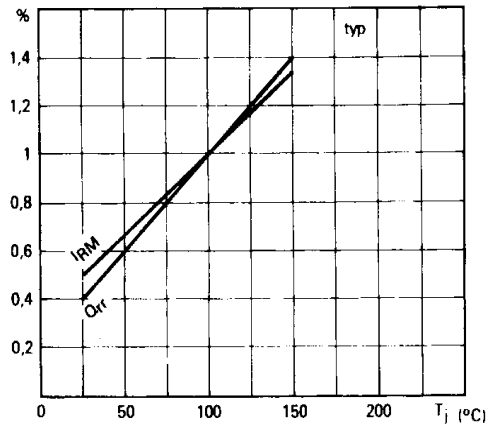

Fig. 11: Turn-off switching characteristics (without series inductance).

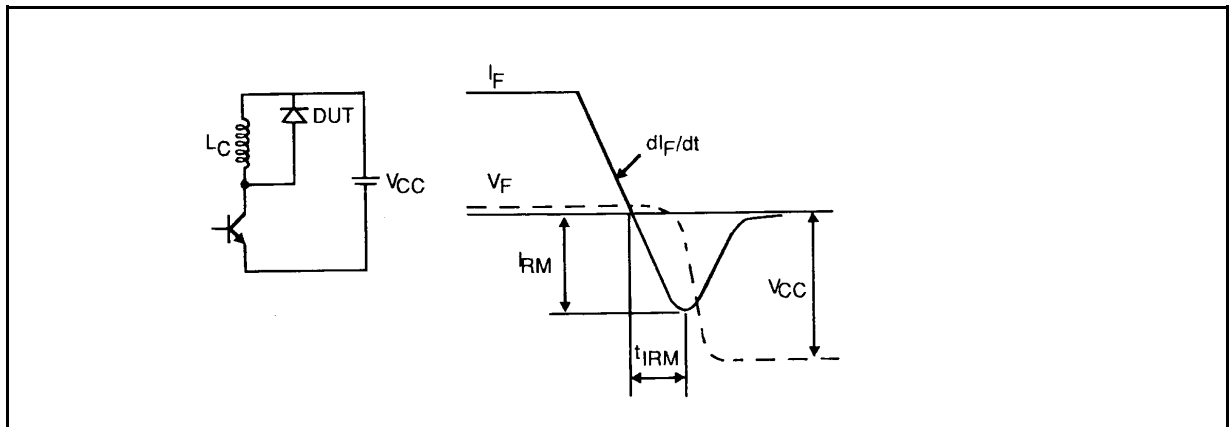
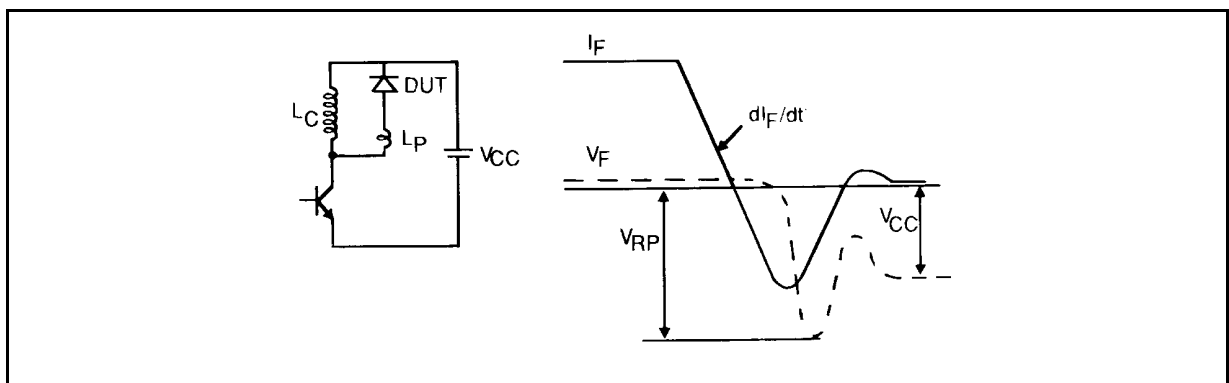
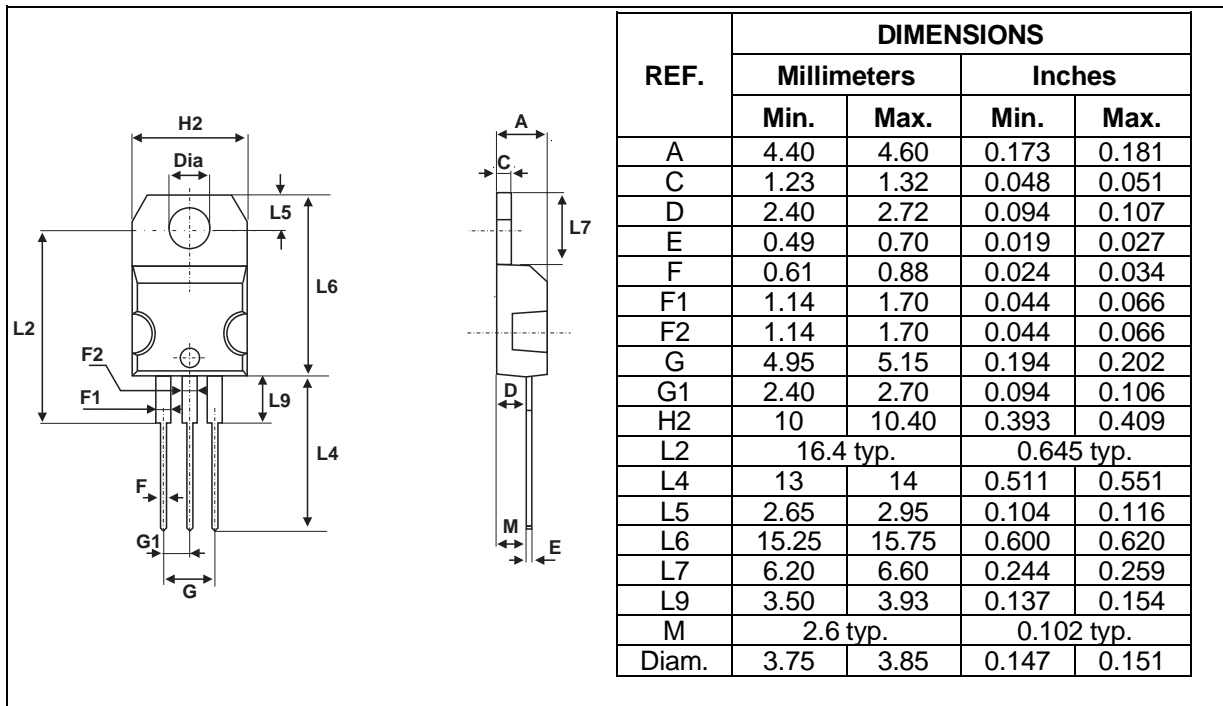

Fig. 12: Turn-off switching characteristics (with series inductance).



PACKAGE MECHANICAL DATA
 TO-220AB

Ordering type	Marking	Package	Weight	Base qty	Delivery mode
BYT16P-400	BYT16P-400	TO-220AB	2.03 g.	30	Tube

- Cooling method: by conduction (C)
- Recommended torque value: 0.08 N.m.
- Maximum torque value: 0.10 N.m.
- Epoxy meets UL94,V0

Information furnished is believed to be accurate and reliable. However, STMicroelectronics assumes no responsibility for the consequences of use of such information nor for any infringement of patents or other rights of third parties which may result from its use. No license is granted by implication or otherwise under any patent or patent rights of STMicroelectronics. Specifications mentioned in this publication are subject to change without notice. This publication supersedes and replaces all information previously supplied. STMicroelectronics products are not authorized for use as critical components in life support devices or systems without express written approval of STMicroelectronics.

The ST logo is a registered trademark of STMicroelectronics

© 1999 STMicroelectronics - Printed in Italy - All rights reserved.

STMicroelectronics GROUP OF COMPANIES

Australia - Brazil - China - Finland - France - Germany - Hong Kong - India - Italy - Japan - Malaysia
 Malta - Morocco - Singapore - Spain - Sweden - Switzerland - United Kingdom - U.S.A.

<http://www.st.com>