

CGA5L3X8R2A334K160AD

TDK Item Description : CGA5L3X8R2A334KT**B



Application & Main Feature

Automotive Grade (Conductive Epoxy Application)

Series

CGA5(3216) [EIA CC1206]

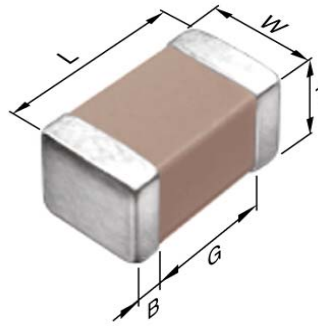

Dimensions

L 3.20mm +0.3,-0.1mm
 W 1.60mm +0.3,-0.1mm
 T 1.60mm +0.3,-0.1mm
 B 0.20mm Min.
 G 1.00mm Min.

Temperature Characteristic

X8R (-55 to 150 degC +/-15%)

Rated Voltage

2A (100Vdc)

Capacitance

330nF

Capacitance Tolerance

K (+/-10%)

Dissipation Factor

3% Max.

Insulation Resistance

1.52Gohm Min.

AEC-Q200

Yes

DC Bias Characteristic

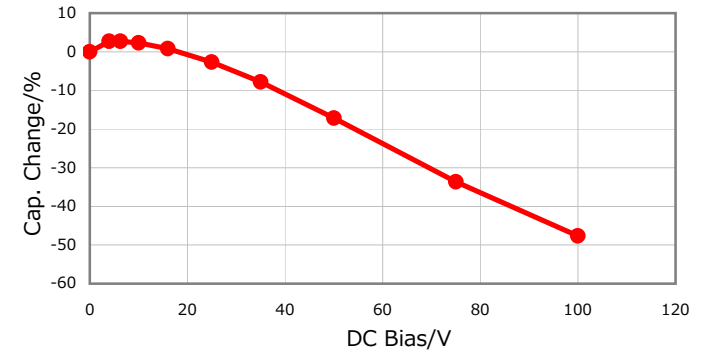

|Z|, ESR vs. Freq. Characteristics

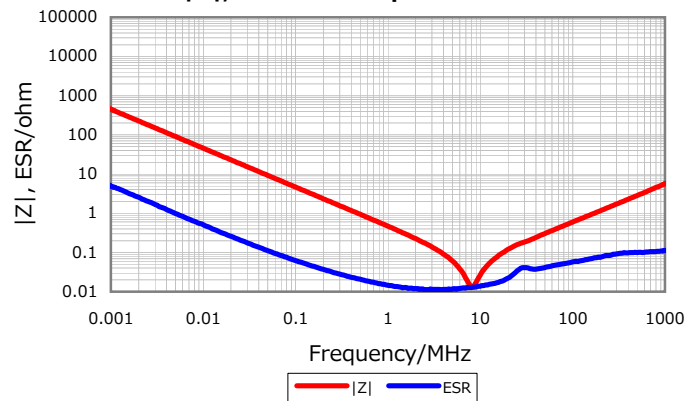

Temperature Characteristics

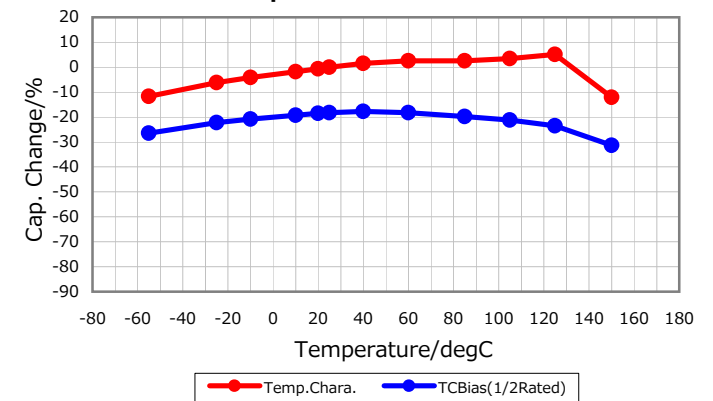

Cap. vs. Freq. Characteristic

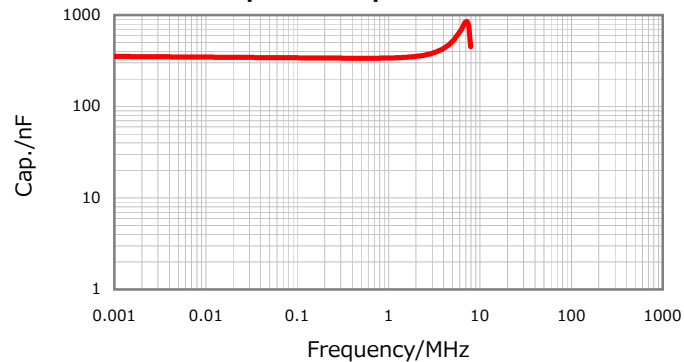

Ripple Temperature Rise Characteristics

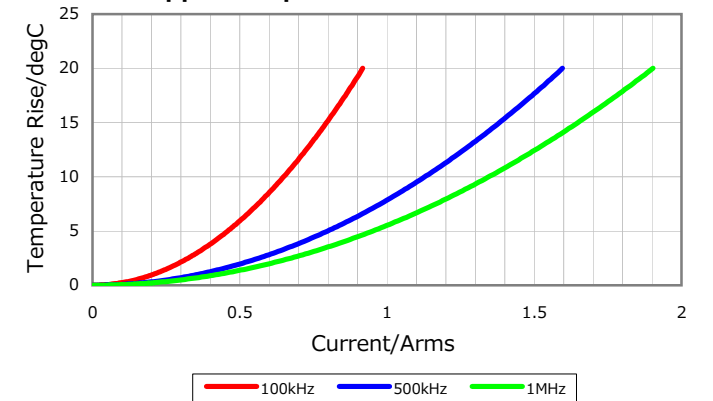

Characterization Sheet (Multilayer Ceramic Chip Capacitors)



All specifications are subject to change without notice.

January 4, 2016