

Features

- Epitaxial planar die construction
- Complementary NPN Type available (PZT2222A)

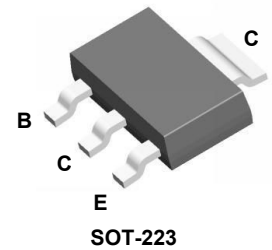

Absolute Maximum Ratings ($T_A = 25\text{ }^\circ\text{C}$ unless otherwise noted)

Parameter	Symbol	Value	Unit
Collector-Base Voltage	V_{CB0}	-60	V
Collector-Emitter Voltage	V_{CEO}	-60	V
Emitter-Base Voltage	V_{EBO}	-5	V
Collector Current - Continuous	I_C	-0.6	A
Collector Power Dissipation	P_C	1	W
Thermal Resistance Junction-to-Ambient ¹	$R_{\theta JA}$	83.3	$^\circ\text{C/W}$
Junction and Storage Temperature	T_J, T_{STG}	-55 to +150	$^\circ\text{C}$

Note 1: FR-4 with 1 oz and 713 mm² of copper area.

Electrical Characteristics ($T_A = 25\text{ }^\circ\text{C}$ unless otherwise noted)

Parameter	Symbol	Test Conditions	Min	Max	Unit
Collector-Base Breakdown Voltage	$V_{(BR)CBO}$	$I_C = -10\mu\text{A}, I_E = 0$	-60	-	V
Collector-Emitter Breakdown Voltage	$V_{(BR)CEO}$	$I_C = -10\text{mA}, I_B = 0$	-60	-	V
Emitter-Base Breakdown Voltage	$V_{(BR)EBO}$	$I_E = -10\mu\text{A}, I_C = 0$	-5	-	V
Collector Cut-Off Current	I_{CBO}	$V_{CB} = -50\text{V}, I_E = 0$	-	-10	nA
Emitter Cut-Off Current	I_{EBO}	$V_{EB} = -5\text{V}, I_C = 0$	-	-50	nA
DC Current Gain	$h_{FE(1)}$	$V_{CE} = -10\text{V}, I_C = -0.1\text{mA}$	75	-	-
	$h_{FE(2)}$	$V_{CE} = -10\text{V}, I_C = -1\text{mA}$	100	-	-
	$h_{FE(3)}$	$V_{CE} = -10\text{V}, I_C = -10\text{mA}$	100	-	-
	$h_{FE(4)}$	$V_{CE} = -10\text{V}, I_C = -150\text{mA}$	100	300	-
	$h_{FE(5)}$	$V_{CE} = -10\text{V}, I_C = -500\text{mA}$	50	-	-
Collector-Emitter Saturation Voltage	$V_{CE(sat)}$	$I_C = -150\text{mA}, I_B = -15\text{mA}$	-	-0.4	V
	$V_{CE(sat)}$	$I_C = -500\text{mA}, I_B = -50\text{mA}$	-	-1.6	V
Base-Emitter Saturation Voltage	$V_{BE(sat)}$	$I_C = -150\text{mA}, I_B = -15\text{mA}$	-	-1.3	V
	$V_{BE(sat)}$	$I_C = -500\text{mA}, I_B = -50\text{mA}$	-	-2.6	V
Transition Frequency	f_T	$V_{CE} = -20\text{V}, I_C = -50\text{mA}, f = 100\text{MHz}$	200	-	MHz
Collector Capacitance	C_c	$V_{CB} = -10\text{V}, I_E = 0, f = 1\text{MHz}$	-	8	pF
Emitter Capacitance	C_E	$V_{EB} = -2\text{V}, I_C = 0, f = 1\text{MHz}$	-	30	pF
Delay Time	t_d	$I_C = -150\text{mA} \quad I_{B1} = -I_{B2} = -15\text{mA}$	-	12	ns
Rise Time	t_r		-	30	ns
Storage Time	t_s		-	300	ns
Fall Time	t_f		-	65	ns
Turn-on Time	t_{on}		-	42	ns
Turn-off Time	t_{off}		-	365	ns

Typical Characteristic Curves

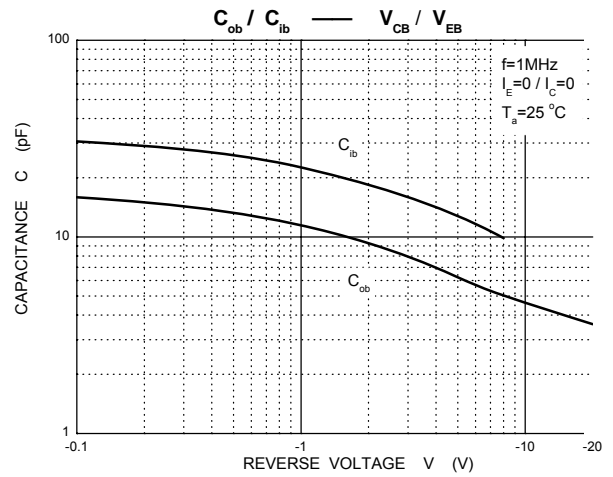
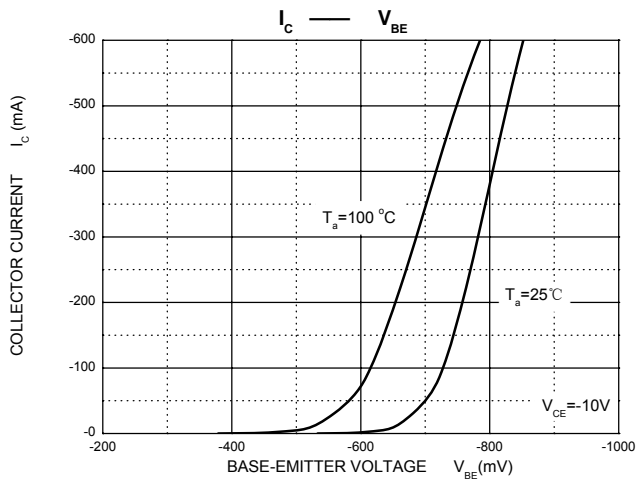
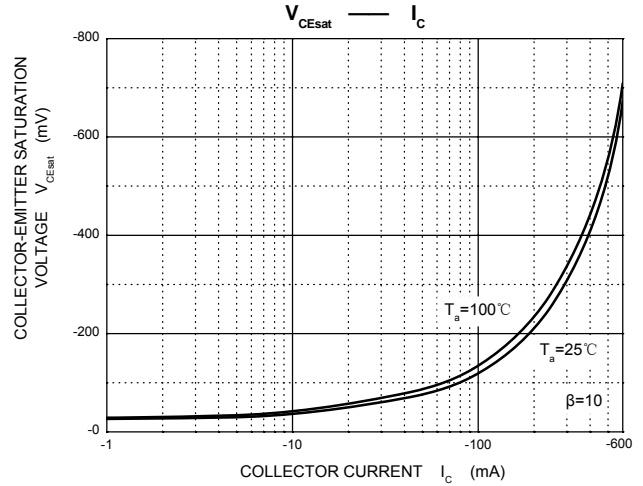
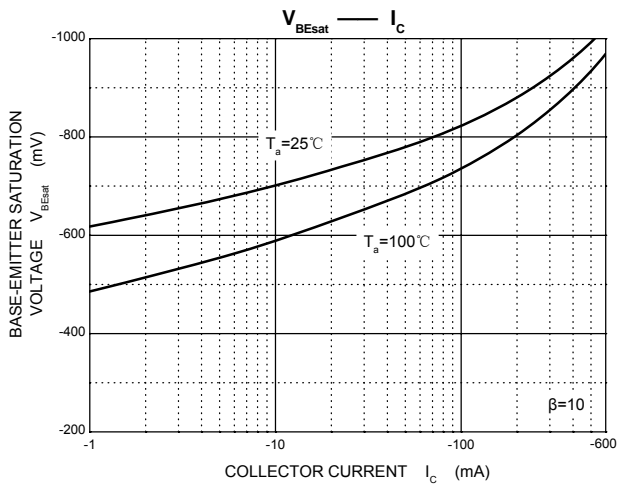
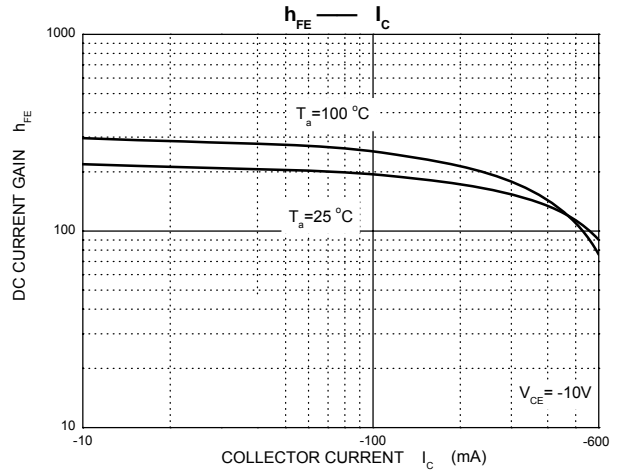
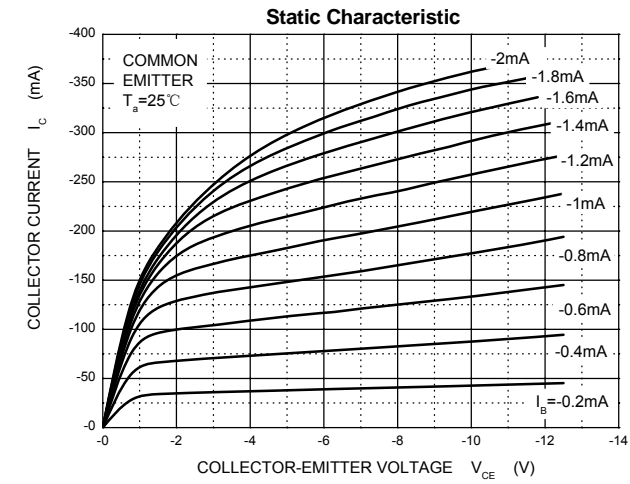

Typical Characteristic Curves

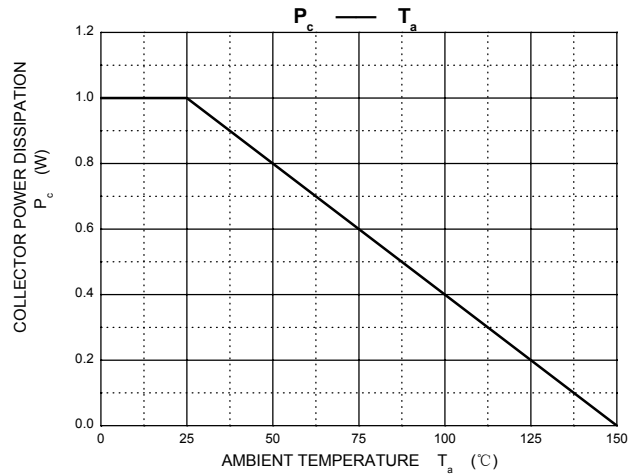
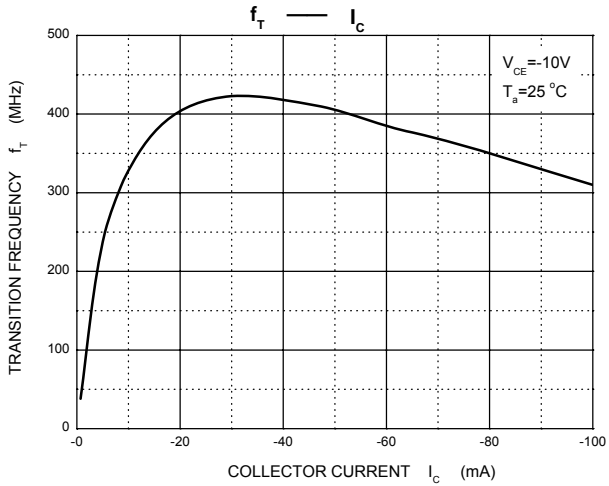

Package Outline Dimensions SOT-223

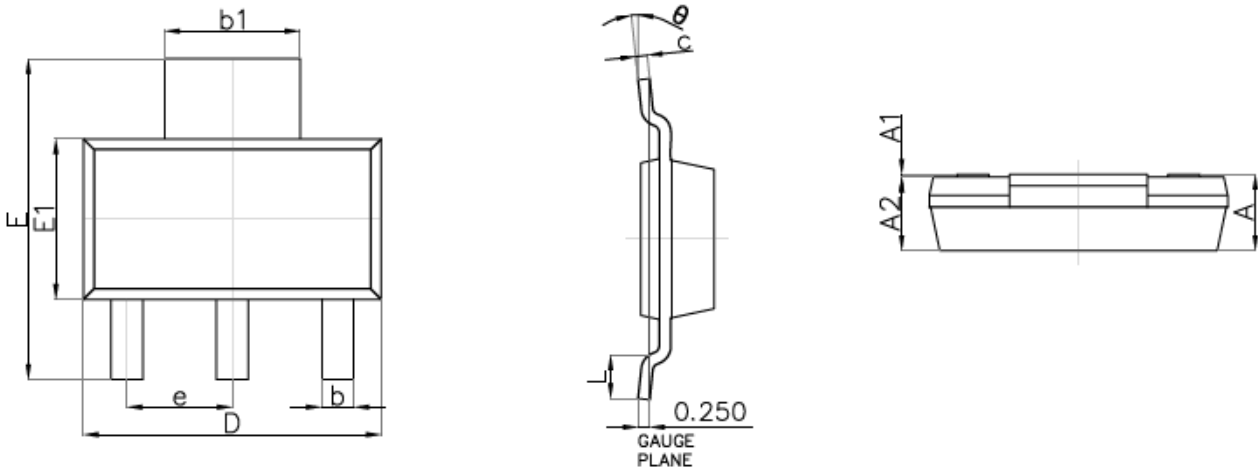

Symbol	Dimensions In Millimeters		Dimensions In Inches	
	Min.	Max.	Min.	Max.
A	—	1.800	—	0.071
A1	0.020	0.100	0.001	0.004
A2	1.500	1.700	0.059	0.067
b	0.660	0.840	0.026	0.033
b1	2.900	3.100	0.114	0.122
c	0.230	0.350	0.009	0.014
D	6.300	6.700	0.248	0.264
E	6.700	7.300	0.264	0.287
E1	3.300	3.700	0.130	0.146
e	2.300(BSC)		0.091(BSC)	
L	0.750	—	0.030	—
θ	0°	10°	0°	10°

Suggested Pad Layout

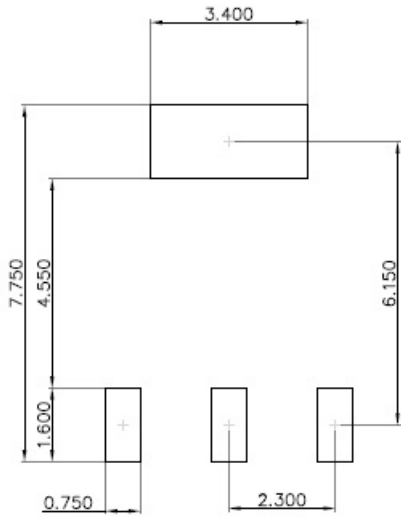

Note:

1. Controlling dimension: in millimeters.
2. General tolerance: ± 0.050 mm.
3. The pad layout is for reference purposes only.

Marking and Ordering Information

Device	Package	Marking	Quantity	HSF Status
PZT2907A	SOT-223	ZT2907A	2500pcs / Reel	RoHS Compliant