

# SMD Power Inductor

## CDH30D14/H125



### Description

- Ferrite drum core construction
- Magnetically unshielded
- LxWxH: 3.2x3.2x1.5 mm Max.
- Product weight: 48mg(Ref.)
- Moisture Sensitivity Level: 1
- Qualification to AEC-Q200

### Environmental Data

- Operating Temperature: -40°C to +125°C (including self-heating)
- Storage temperature range: -40°C~+125°C

### Packaging

- Carrier tape and reel packaging

### Applications

- High temp and high reliability automotive applications



### Dimension - [mm]

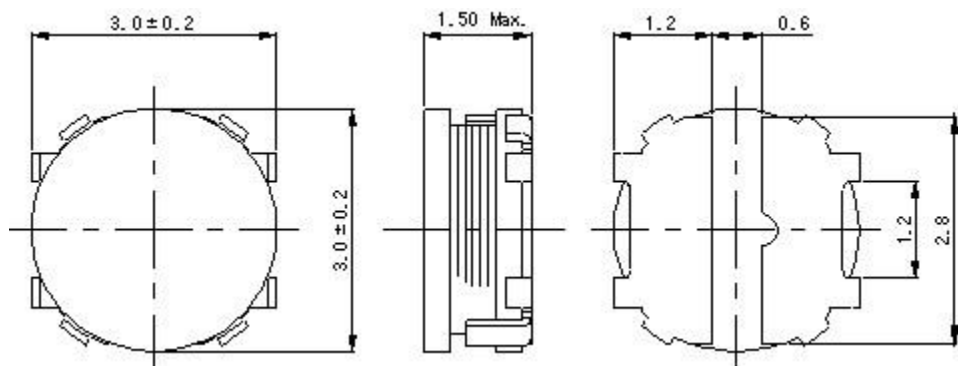

### Recommended Land pattern - [mm]

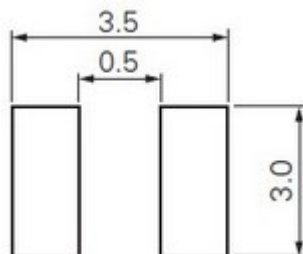

### Wire Connection

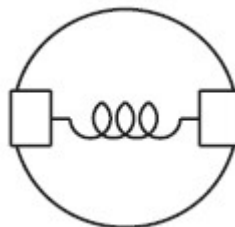

# SMD Power Inductor

## CDH30D14/H125



### Electrical Characteristics

Part Number	Inductance [Within] ( $\mu$ H) ※1	D.C.R. at 20°C Max.(Typ.) (m $\Omega$ )	Saturation Current (A) Max.(Typ.) ※2		Temperature Rise Current (A) Max.(Typ.) ※3
			20°C	125°C	
CDH30D14H125NP-1R0MC	1.00 $\pm$ 20%	68.80 (55.00)	2.70 (3.65)	2.20 (2.85)	1.97 (2.30)
CDH30D14H125NP-2R2MC	2.20 $\pm$ 20%	131 (105)	1.90 (2.46)	1.50 (1.93)	1.40 (1.60)
CDH30D14H125NP-3R3MC	3.30 $\pm$ 20%	194 (155)	1.50 (1.86)	1.30 (1.52)	1.12 (1.30)
CDH30D14H125NP-4R7MC	4.70 $\pm$ 20%	250 (200)	1.30 (1.64)	1.10 (1.34)	1.05 (1.20)
CDH30D14H125NP-5R6MC	5.60 $\pm$ 20%	313 (250)	1.10 (1.43)	0.95 (1.15)	0.77 (0.90)
CDH30D14H125NP-6R8MC	6.80 $\pm$ 20%	438 (350)	1.00 (1.33)	0.80 (1.07)	0.68 (0.78)
CDH30D14H125NP-100MC	10.00 $\pm$ 20%	650 (520)	0.95 (1.12)	0.70 (0.85)	0.57 (0.64)

※1 Measuring frequency inductance at 100kHz,1V.

※2 Allowable D.C. bias current: the value of D.C. current when inductance is above 70% of its initial value.

※3 Temperature rise current: the actual value of D.C. current when temperature of coil increased

$\Delta T=40^{\circ}\text{C}(T_a=20^{\circ}\text{C})$ .

### Solder Reflow Condition

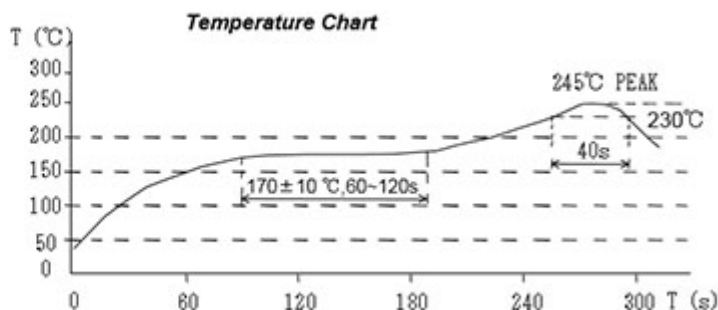
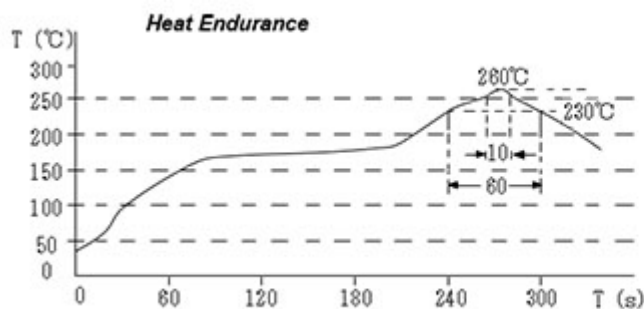

# SMD Power Inductor

## CDH30D14/H125



### Saturation Current & Temperature Rise Graph

— L (20°C) — L (125°C) —  $\Delta T$

1. CDH30D14H125NP-1R0MC

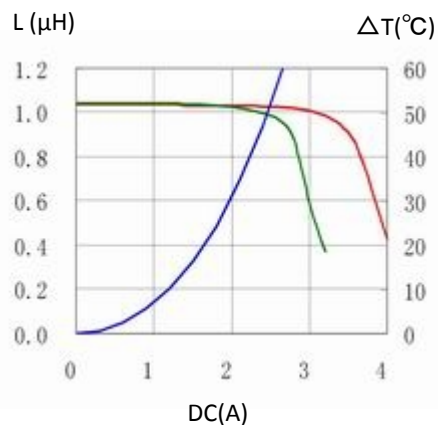

2. CDH30D14H125NP-2R2MC

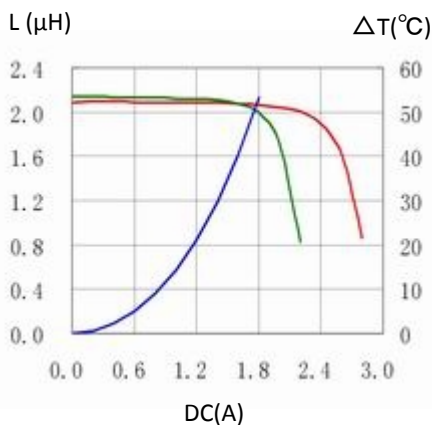

3. CDH30D14H125NP-3R3MC

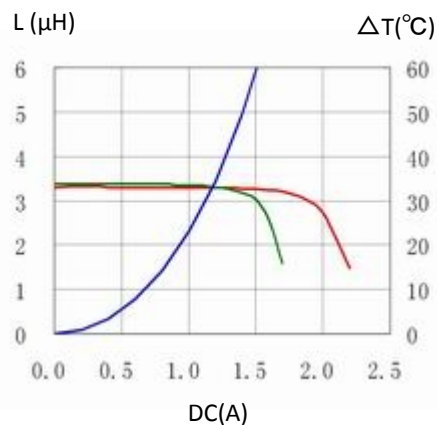

4. CDH30D14H125NP-4R7MC

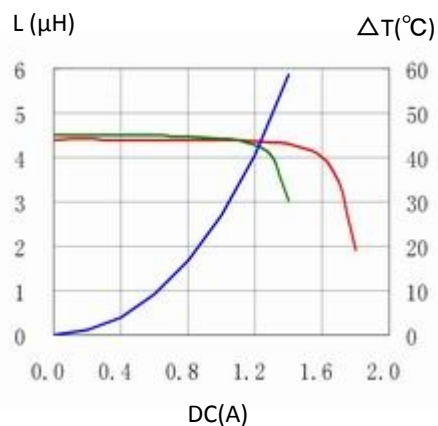

5. CDH30D14H125NP-5R6MC

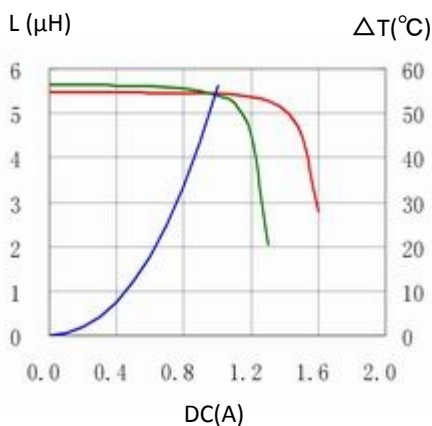

6. CDH30D14H125NP-6R8MC

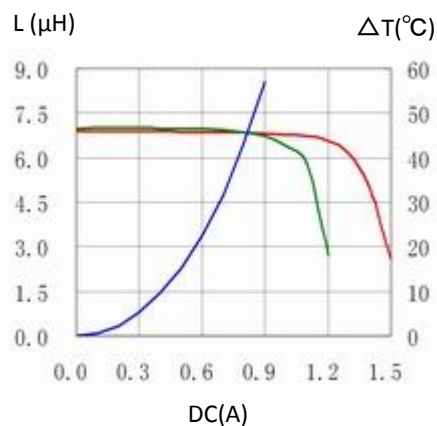

7. CDH30D14H125NP-100MC

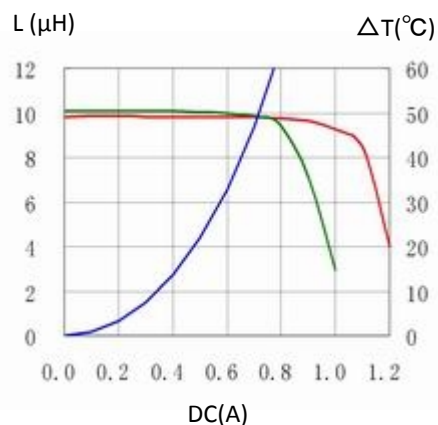

Note: This specification is subject to change without notice. Please contact your nearest sales office for updated information when placing an order.

# SMD Power Inductor

## CDH30D14/H125



Recommended Type



For sales office information, please [click here](#) to visit our website.