

CMOS 8-STAGE STATIC SHIFT REGISTER

Check for Samples: [CD4021B-Q1](#)

FEATURES

- Qualified for Automotive Applications
- Medium-Speed Operation: 12-MHz (Typ) Clock Rate at $V_{DD} - V_{SS} = 10\text{ V}$
- Fully Static Operation
- Eight Master-Slave Flip-Flops Plus Output Buffering and Control Gating
- 100% Tested for Quiescent Current at 20 V
- Maximum Input Current of 1 μA at 18 V Over Full Package-Temperature Range: 100 nA at 18 V and 25°C
- Noise Margin (Full Package-Temperature Range):
 - 1 V at $V_{DD} = 5\text{ V}$
 - 2 V at $V_{DD} = 10\text{ V}$
 - 2.5 V at $V_{DD} = 15\text{ V}$
- Standardized Symmetrical Output Characteristics
- 5-V, 10-V, and 15-V Parametric Ratings

- Meets All Requirements of JEDEC Tentative Standard No. 13B, "Standard Specifications for Description of 'B' Series CMOS Devices"
- Latch-Up Performance Meets 50 mA per JESD 78, Class I

APPLICATIONS

- Parallel Input/Serial Output Data Queuing
- Parallel-to-Serial Data Conversion
- General-Purpose Register

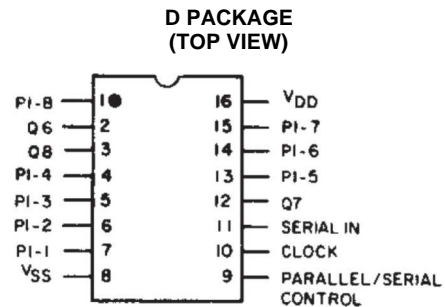

DESCRIPTION

CD4021B series types are 8-stage parallel- or serial-input/serial output registers having common CLOCK and PARALLEL/SERIAL CONTROL inputs, a single SERIAL data input, and individual parallel "JAM" inputs to each register stage. Each register stage is a D-type, master-slave flip-flop. In addition to an output from stage 8, "Q" outputs are also available from stages 6 and 7. Parallel as well as serial entry is made into the register synchronously with the positive clock line transition in the CD4014B. In the CD4021B serial entry is synchronous with the clock but parallel entry is asynchronous. In both types, entry is controlled by the PARALLEL/SERIAL CONTROL input. When the PARALLEL/SERIAL CONTROL input is low, data is serially shifted into the 8-stage register synchronously with the positive transition of the clock line. When the PARALLEL/SERIAL CONTROL input is high, data is jammed into the 8-stage register via the parallel input lines and synchronous with the positive transition of the clock line. In the CD4021B, the CLOCK input of the internal stage is "forced" when asynchronous parallel entry is made. Register expansion using multiple packages is permitted.

The CD4021B series types are supplied in 16-lead hermetic dual-in-line ceramic packages (D and F suffixes), 16-lead dual-in-line plastic packages (E suffix), and in chip form (H suffix).

ORDERING INFORMATION⁽¹⁾

T_A	PACKAGE ⁽²⁾		ORDERABLE PART NUMBER	TOP-SIDE MARKING
–40°C to 125°C	SOIC – D	Reel of 2500	CD4010BQDRQ1	CD4021BQ

(1) For the most current package and ordering information, see the Package Option Addendum at the end of this document, or see the TI web site at www.ti.com.

(2) Package drawings, thermal data, and symbolization are available at www.ti.com/packaging.



Please be aware that an important notice concerning availability, standard warranty, and use in critical applications of Texas Instruments semiconductor products and disclaimers thereto appears at the end of this data sheet.



This integrated circuit can be damaged by ESD. Texas Instruments recommends that all integrated circuits be handled with appropriate precautions. Failure to observe proper handling and installation procedures can cause damage.

ESD damage can range from subtle performance degradation to complete device failure. Precision integrated circuits may be more susceptible to damage because very small parametric changes could cause the device not to meet its published specifications.

Functional Diagram

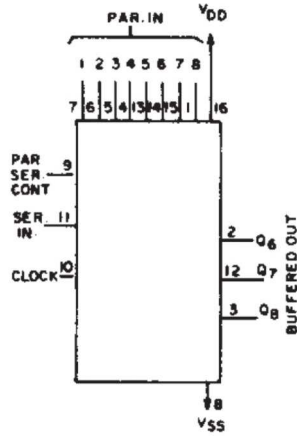

Logic Diagram

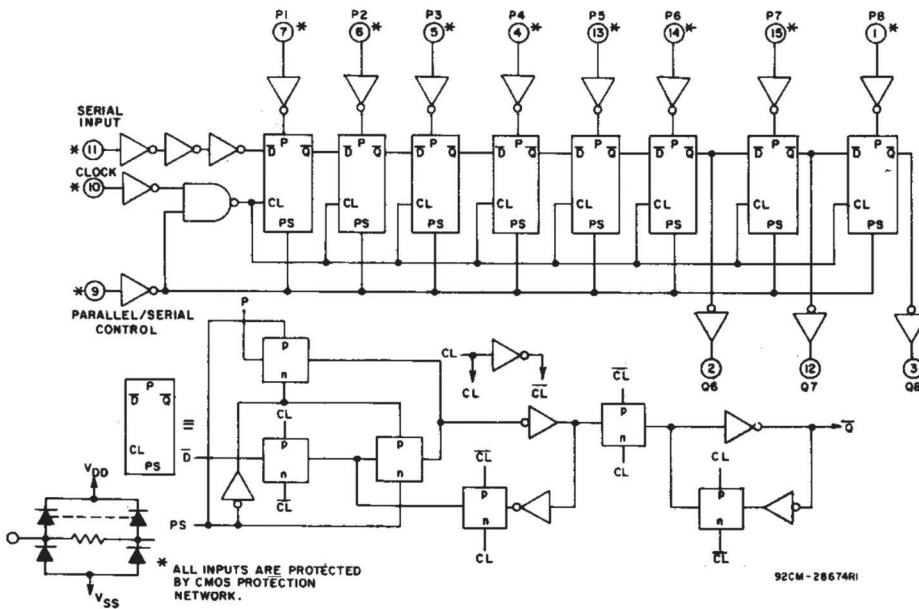

TRUTH TABLE – CD4021B

CL	Serial Input	Parallel/Serial Control	PI-1	PI-n	Q1 (Internal)	Qn
X	X	1	0	0	0	0
X	X	1	0	1	0	1
X	X	1	1	0	1	0
X	X	1	1	1	1	1
	0	0	X	X	0	Q _{n-1}
	1	0	X	X	1	Q _{n-1}
	X	0	X	X	Q ₁	Q _n NC

X = DON'T CARE CASE

ABSOLUTE MAXIMUM RATINGS⁽¹⁾

over operating free-air temperature range (unless otherwise noted)

		VALUE	UNIT
V _{DD}	DC supply voltage range (voltage referenced to V _{SS} terminal)	–0.5 to +20	V
	Input voltage range, all inputs	–0.5 to V _{DD} +0.5	V
	DC input current, any one input	±10	mA
P _D	Power dissipation per package	T _A = –40°C to +100°C	500
		T _A = +100°C to +125°C	Derate Linearity at 12mW/°C to 20 mW
P _D	Device dissipation per output transistor	100	mW
T _A	Operating temperature range	–40 to +125	°C
T _{stg}	Storage temperature range	–65 to +150	°C
ESD	Electrostatic discharge rating ⁽²⁾	Human-body model (HBM)	2000
		Machine model (MM)	200
		Charged-Device Model (CDM)	1000
Latch-up performance per JESD 78, Class I		50	mA

- (1) Stresses beyond those listed under *absolute maximum ratings* may cause permanent damage to the device. These are stress ratings only, and functional operation of the device at these or any other conditions beyond those indicated under *recommended operating conditions* is not implied. Exposure to absolute-maximum-rated conditions for extended periods may affect device reliability.
- (2) Tested in accordance with AEC-Q100.

RECOMMENDED OPERATING CONDITIONS

At $T_A = 25^\circ\text{C}$, unless otherwise specified. For maximum reliability, nominal operating conditions should be selected so that operation is always within the following ranges.

		V_{DD}	MIN	MAX	UNIT
	Supply voltage range ($T_A =$ full package-temperature range)		3	18	V
t_W	Clock pulse width	5	180		ns
		10	80		
		15	50		
f_{CL}	Clock frequency	5		3	MHz
		10		6	
		15		8.5	
t_{rCL} , t_{fCL}	Clock rise and fall time	5		15	μs
		10		15	
		15		15	
t_s	Serial input (referred to CL)	5	120		ns
		10	80		
		15	60		
	Parallel inputs CD4014B (referred to CL)	5	80		ns
		10	50		
		15	40		
	Parallel inputs CD4021B (referred to P/S)	5	50		ns
		10	30		
		15	20		
	Parallel/Serial Control CD4014B (referred to CL)	5	180		ns
		10	80		
		15	60		
t_W	Parallel/serial pulse width	5	160		ns
		10	80		
		15	50		
t_{REM}	Parallel/serial removal time	5	280		ns
		10	140		
		15	100		

STATIC ELECTRICAL CHARACTERISTICS

PARAMETER	TEST CONDITIONS			LIMITS AT INDICATED TEMPERATURES (°C)						UNIT
	V _D (V)	V _{IN} (V)	V _{DD} (V)	-40	+85	+125	+25			
							5	150	150	
I _{DD} Max Quiescent device current		0.5	5	10	300	300	0.04		5	μA
		0.10	10	20	600	600	0.04		10	
		0.15	15	100	3000	3000	0.04		20	
		0.20	20	0.61	0.42	0.36	0.08		100	
I _{OL} Min Output low (sink) current	0.4	0.5	5	1.5	1.1	0.9	0.51	1		mA
	0.5	0.10	10	4	2.8	2.4	1.3	2.6		
	1.5	0.15	15	-0.61	-0.42	-0.36	3.4	6.8		
I _{OH} Min Output high (source) current	4.6	0.5	5	-1.8	-1.3	-1.15	-0.51	-1		
	2.5	0.5	5	-1.5	-1.1	-0.9	-1.6	-3.2		
	9.5	0.10	10	-4	-2.8	-2.4	-1.3	-2.6		
V _{OL} Max Output voltage: low level		0.5	5	0.05			0		0.05	V
		0.10	10	0.05			0		0.05	
		0.15	15	0.05			0		0.05	
V _{OH} Min Output voltage: high level		0.5	5	4.95			4.95	5		
		0.10	10	9.95			9.95	10		
		0.15	15	14.95			14.95	15		
V _{IL} Max Input low voltage	0.5, 4.5		5	1.5					1.5	V
	1, 9		10	3					3	
	1.5, 13.5		15	4					4	
V _{IH} Min Input high voltage	0.5, 4.5		5	3.5			3.5			
	1, 9		10	7			7			
	1.5, 13.5		15	11			11			
I _{IN} Max Input current		0, 18	18	±0.1	±1	±1	±10 ⁻⁵		±0.1	μA

DYNAMIC ELECTRICAL CHARACTERISTICS
 $T_A = 25^\circ\text{C}$, Input $t_r/t_f = 20\text{ ns}$, $C_L = 50\text{ pF}$, $R_L = 200\text{ k}\Omega$

PARAMETER		TEST CONDITIONS	V_{DD}	MIN	TYP	MAX	UNIT
t_{PLH} , t_{PHL}	Propagation delay time		5		160	320	ns
			10		80	160	
			15		30	120	
t_{THL} , t_{TLH}	Transition time		5		100	200	ns
			10		50	100	
			15		40	80	
f_{CL}	Maximum clock input ⁽¹⁾		5	3	6		MHz
			10	6	12		
			15	8.5	17		
t_W	Minimum clock pulse width ⁽¹⁾		5		90	180	ns
			10		40	80	
			15		25	50	
t_{rCL} , t_{fCL}	Clock rise and fall time ⁽²⁾⁽¹⁾		5			15	μs
			10			15	
			15			15	
t_s	Minimum setup time ⁽¹⁾	Serial input (referred to CL)	5		60	120	ns
			10		40	80	
			15		30	60	
		Parallel inputs (referred to CL)	5		40	80	
			10		25	50	
			15		20	40	
		Parallel inputs (referred to P/S)	5		25	50	
			10		15	30	
			15		10	20	
		Serial in, Parallel in, Parallel/Serial Control	5		90	180	
			10		40	80	
			15		30	60	
t_H	Minimum hold time ⁽¹⁾		5			0	ns
			10			0	
			15			0	
t_{WH}	Minimum P/S pulse width ⁽¹⁾		5		80	160	ns
			10		40	80	
			15		25	50	
t_{REM}	Minimum P/S removal time ⁽¹⁾		5		140	280	ns
			10		70	140	
			15		50	100	
C_I	Average input capacitance ⁽¹⁾			5	7.5	pF	

(1) Not production tested

(2) If more than one unit is cascaded, t_{rCL} should be made less than or equal to the sum of the transition time and the fixed propagation delay of the output of the driving stage for the estimated capacitive load.

Typical Characteristics

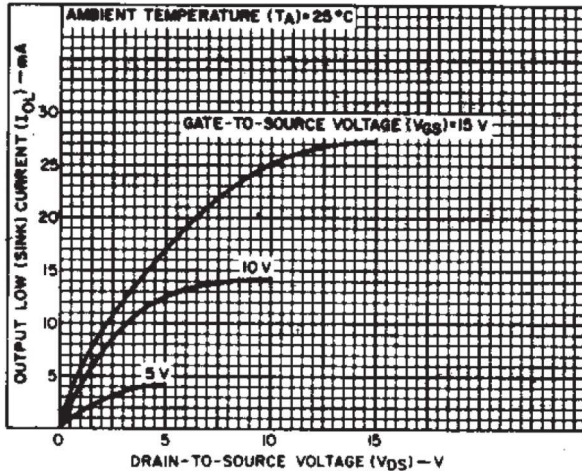

Figure 1. Typical Output Low (Sink) Current Characteristics

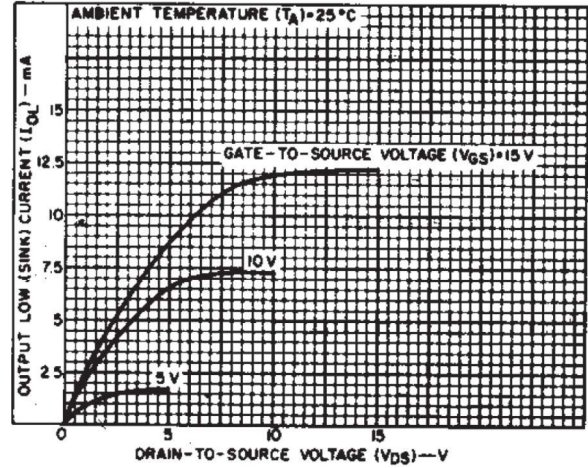

Figure 2. Minimum Output Low (Sink) Current Characteristics

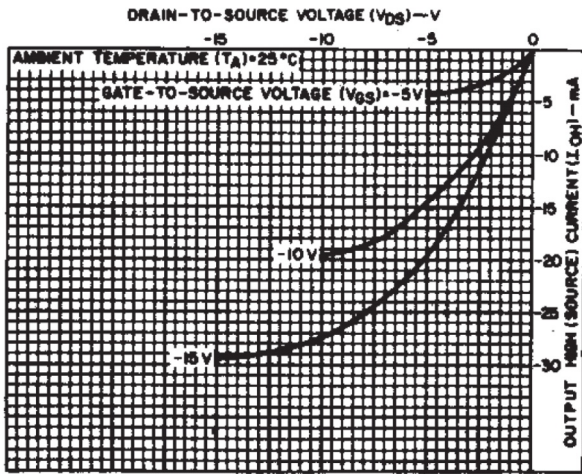

Figure 3. Typical Output High (Source) Current Characteristics

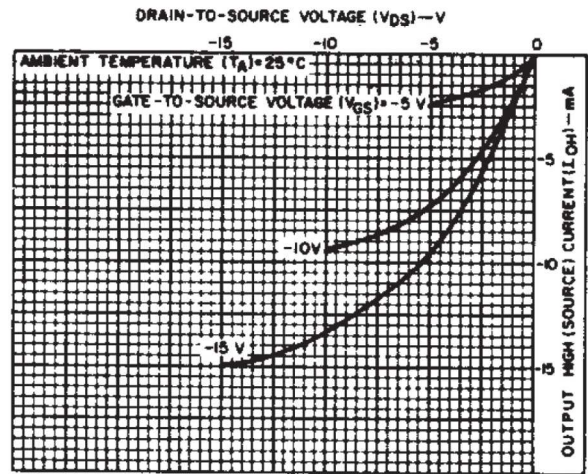

Figure 4. Minimum Output High (Source) Current Characteristics

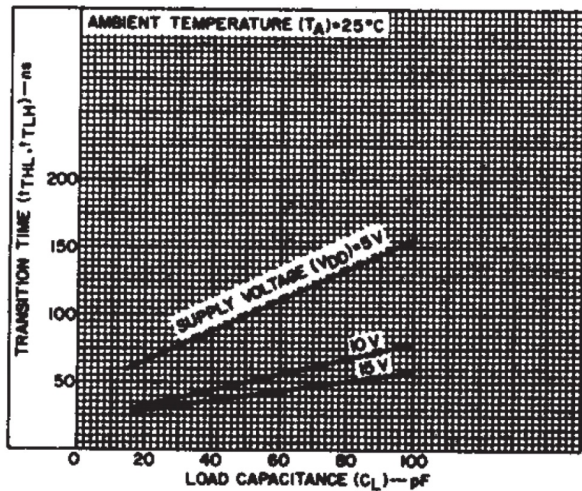

Figure 5. Typical Transition Time as a Function of Load Capacitance

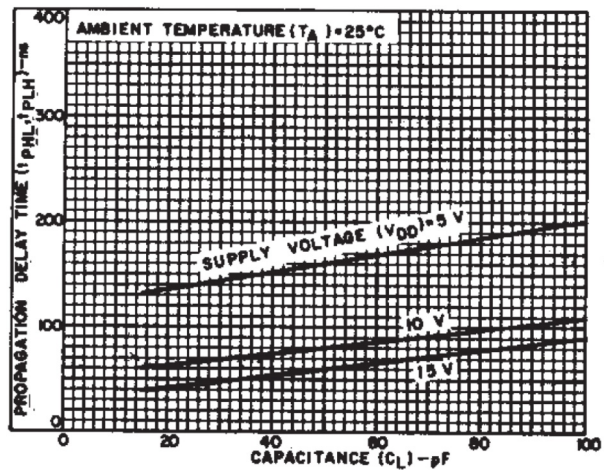

Figure 6. Typical Propagation Delay Times as a Function of Load Capacitance

PARAMETER MEASUREMENT INFORMATION

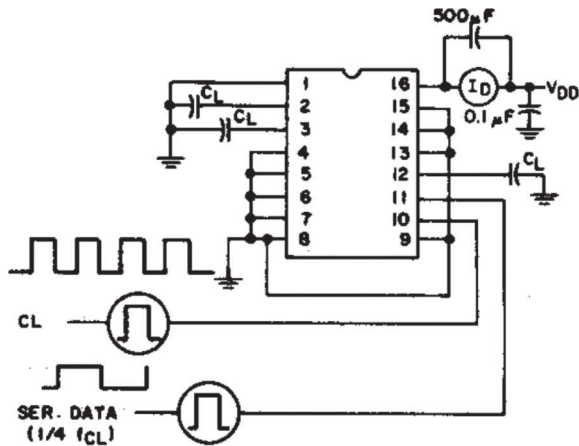

Figure 8. Dynamic Power Dissipation Test Circuit

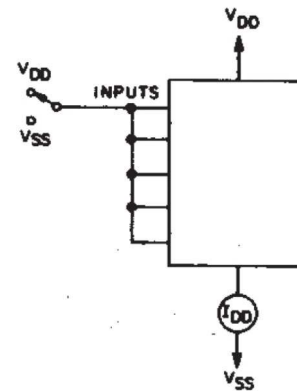

Figure 9. Quiescent Device Current Test Circuit

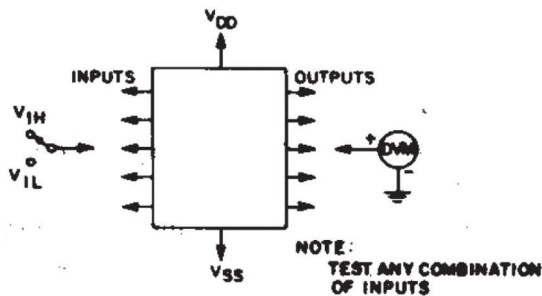

Figure 10. Input Voltage Test Circuit

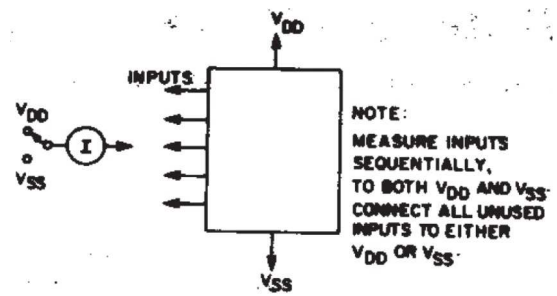
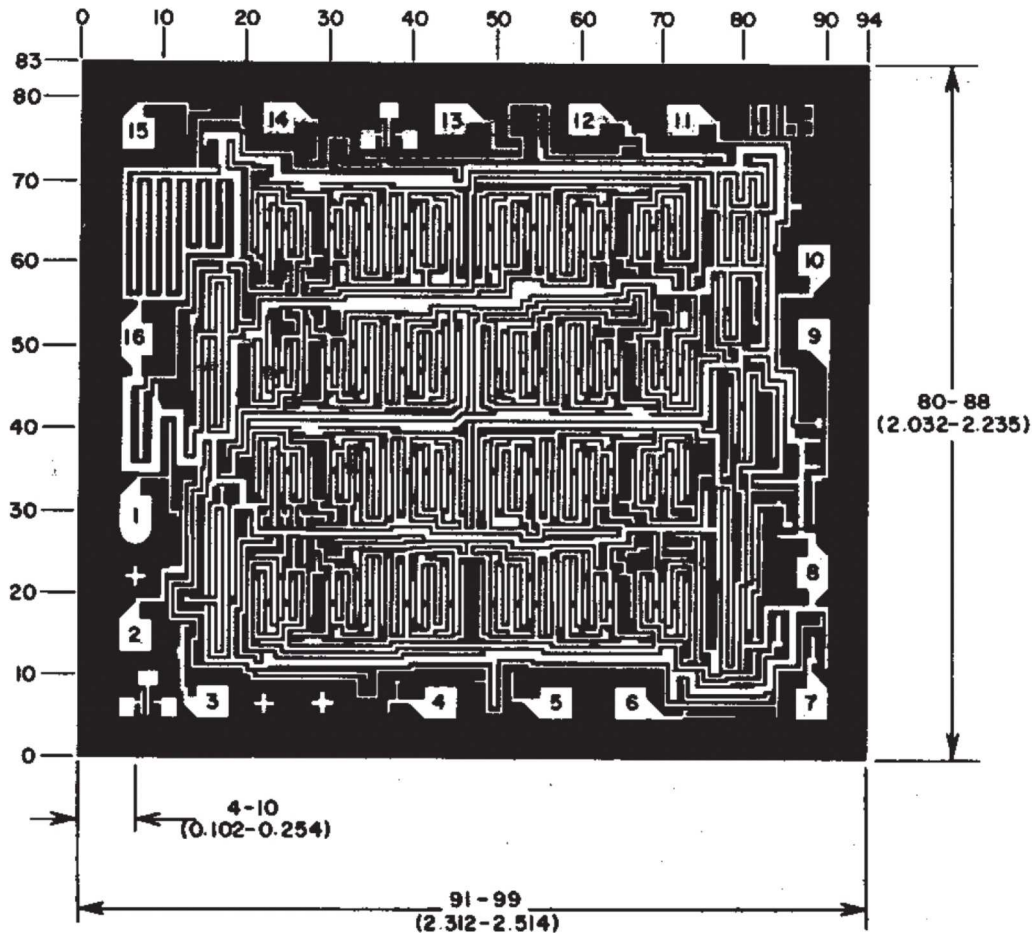

Figure 11. Input Current Test Circuit



Note: Dimensions in parentheses are in millimeters and are derived from the basic inch dimensions as indicated. Grid graduation are in mils (10^{-3} inch).

Figure 12. Dimensions and Pad Layout

PACKAGING INFORMATION

Orderable Device	Status (1)	Package Type	Package Drawing	Pins	Package Qty	Eco Plan (2)	Lead finish/ Ball material (6)	MSL Peak Temp (3)	Op Temp (°C)	Device Marking (4/5)	Samples
CD4021BQDRQ1	ACTIVE	SOIC	D	16	2500	RoHS & Green	NIPDAU	Level-1-260C-UNLIM	-40 to 125	CD4021BQ	Samples

(1) The marketing status values are defined as follows:

ACTIVE: Product device recommended for new designs.

LIFEBUY: TI has announced that the device will be discontinued, and a lifetime-buy period is in effect.

NRND: Not recommended for new designs. Device is in production to support existing customers, but TI does not recommend using this part in a new design.

PREVIEW: Device has been announced but is not in production. Samples may or may not be available.

OBSOLETE: TI has discontinued the production of the device.

(2) **RoHS:** TI defines "RoHS" to mean semiconductor products that are compliant with the current EU RoHS requirements for all 10 RoHS substances, including the requirement that RoHS substance do not exceed 0.1% by weight in homogeneous materials. Where designed to be soldered at high temperatures, "RoHS" products are suitable for use in specified lead-free processes. TI may reference these types of products as "Pb-Free".

RoHS Exempt: TI defines "RoHS Exempt" to mean products that contain lead but are compliant with EU RoHS pursuant to a specific EU RoHS exemption.

Green: TI defines "Green" to mean the content of Chlorine (Cl) and Bromine (Br) based flame retardants meet JS709B low halogen requirements of <=1000ppm threshold. Antimony trioxide based flame retardants must also meet the <=1000ppm threshold requirement.

(3) MSL, Peak Temp. - The Moisture Sensitivity Level rating according to the JEDEC industry standard classifications, and peak solder temperature.

(4) There may be additional marking, which relates to the logo, the lot trace code information, or the environmental category on the device.

(5) Multiple Device Markings will be inside parentheses. Only one Device Marking contained in parentheses and separated by a "-" will appear on a device. If a line is indented then it is a continuation of the previous line and the two combined represent the entire Device Marking for that device.

(6) Lead finish/Ball material - Orderable Devices may have multiple material finish options. Finish options are separated by a vertical ruled line. Lead finish/Ball material values may wrap to two lines if the finish value exceeds the maximum column width.

Important Information and Disclaimer:The information provided on this page represents TI's knowledge and belief as of the date that it is provided. TI bases its knowledge and belief on information provided by third parties, and makes no representation or warranty as to the accuracy of such information. Efforts are underway to better integrate information from third parties. TI has taken and continues to take reasonable steps to provide representative and accurate information but may not have conducted destructive testing or chemical analysis on incoming materials and chemicals. TI and TI suppliers consider certain information to be proprietary, and thus CAS numbers and other limited information may not be available for release.

In no event shall TI's liability arising out of such information exceed the total purchase price of the TI part(s) at issue in this document sold by TI to Customer on an annual basis.

OTHER QUALIFIED VERSIONS OF CD4021B-Q1 :

- Catalog: [CD4021B](#)
- Military: [CD4021B-MIL](#)

NOTE: Qualified Version Definitions:

- Catalog - TI's standard catalog product
- Military - QML certified for Military and Defense Applications

D (R-PDSO-G16)

PLASTIC SMALL OUTLINE



- NOTES:
- A. All linear dimensions are in inches (millimeters).
 - B. This drawing is subject to change without notice.
 - C. Body length does not include mold flash, protrusions, or gate burrs. Mold flash, protrusions, or gate burrs shall not exceed 0.006 (0,15) each side.
 - D. Body width does not include interlead flash. Interlead flash shall not exceed 0.017 (0,43) each side.
 - E. Reference JEDEC MS-012 variation AC.

D (R-PDSO-G16)

PLASTIC SMALL OUTLINE



- NOTES:
- All linear dimensions are in millimeters.
 - This drawing is subject to change without notice.
 - Publication IPC-7351 is recommended for alternate designs.
 - Laser cutting apertures with trapezoidal walls and also rounding corners will offer better paste release. Customers should contact their board assembly site for stencil design recommendations. Refer to IPC-7525 for other stencil recommendations.
 - Customers should contact their board fabrication site for solder mask tolerances between and around signal pads.

IMPORTANT NOTICE AND DISCLAIMER

TI PROVIDES TECHNICAL AND RELIABILITY DATA (INCLUDING DATASHEETS), DESIGN RESOURCES (INCLUDING REFERENCE DESIGNS), APPLICATION OR OTHER DESIGN ADVICE, WEB TOOLS, SAFETY INFORMATION, AND OTHER RESOURCES "AS IS" AND WITH ALL FAULTS, AND DISCLAIMS ALL WARRANTIES, EXPRESS AND IMPLIED, INCLUDING WITHOUT LIMITATION ANY IMPLIED WARRANTIES OF MERCHANTABILITY, FITNESS FOR A PARTICULAR PURPOSE OR NON-INFRINGEMENT OF THIRD PARTY INTELLECTUAL PROPERTY RIGHTS.

These resources are intended for skilled developers designing with TI products. You are solely responsible for (1) selecting the appropriate TI products for your application, (2) designing, validating and testing your application, and (3) ensuring your application meets applicable standards, and any other safety, security, or other requirements. These resources are subject to change without notice. TI grants you permission to use these resources only for development of an application that uses the TI products described in the resource. Other reproduction and display of these resources is prohibited. No license is granted to any other TI intellectual property right or to any third party intellectual property right. TI disclaims responsibility for, and you will fully indemnify TI and its representatives against, any claims, damages, costs, losses, and liabilities arising out of your use of these resources.

TI's products are provided subject to TI's Terms of Sale (www.ti.com/legal/termsofsale.html) or other applicable terms available either on ti.com or provided in conjunction with such TI products. TI's provision of these resources does not expand or otherwise alter TI's applicable warranties or warranty disclaimers for TI products.

Mailing Address: Texas Instruments, Post Office Box 655303, Dallas, Texas 75265
Copyright © 2020, Texas Instruments Incorporated