

PQ7RV4

Variable Output (1.5 to 7V), 4.6A Output Low Power-loss Voltage Regulator

■ Features

- Low power-loss
(Dropout voltage : MAX.0.5V at $I_o=4.0A$)
(Dropout voltage : MAX.1.0V at $I_o=4.6A$)
- TO-220 package
- 1.5V to 7V/4.6A output type
- Low operating voltage (Minimum operating voltage:3.0V)
- High-precision reference voltage type
Reference voltage precision : $\pm 2.0\%$
- Built-in overcurrent protection, overheat protection function

■ Applications

- Power supplies for various electronic equipment such as personal computers

■ Outline Dimensions

(Unit : mm)

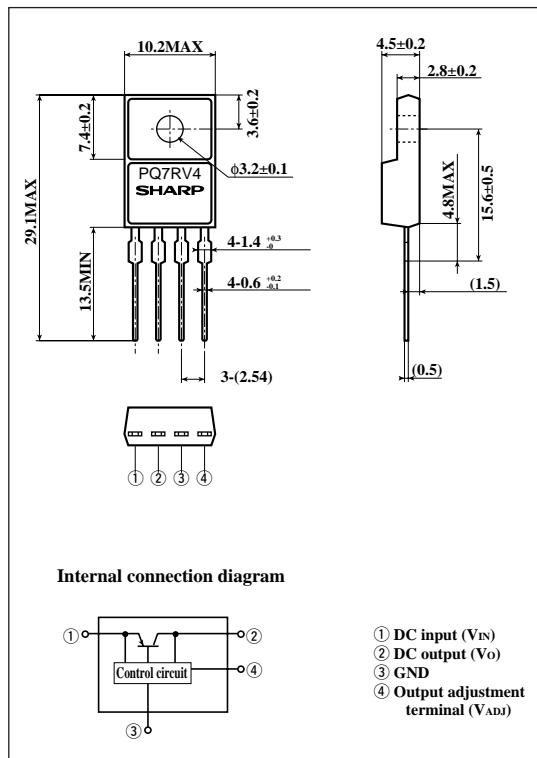

■ Absolute Maximum Ratings

($T_a=25^{\circ}C$)

Parameter	Symbol	Rating	Unit
*1 Input voltage	V_{IN}	10	V
*1 ON/OFF control terminal voltage	V_{ADJ}	5	V
Output current	I_o	4.6	A
*2 Power dissipation	P_{D1}	1.8	W
	P_{D2}	18	
*3 Junction temperature	T_j	150	$^{\circ}C$
Operating temperature	T_{opr}	-20 to +80	$^{\circ}C$
Storage temperature	T_{stg}	-40 to +150	$^{\circ}C$
Soldering temperature	T_{sol}	260 (For 10s)	$^{\circ}C$

*1 All are open except GND and applicable terminals.

*2 P_{D1} : No heat sink, P_{D2} : With infinite heat sink

*3 Overheat protection may operate at $125 \leq T_j \leq 150^{\circ}C$.

■ **Electrical Characteristics** (Unless otherwise specified, conditions shall be $V_{IN}=5V, V_O=3.3V(R_1=2k\Omega), I_O=2.0A, T_a=25^\circ C$)

Parameter	Symbol	Conditions	MIN.	TYP.	MAX.	Unit
Input voltage	V_{IN}	-	3.0	-	10.0	V
Output voltage	V_O	-	1.5	-	7.0	V
Load regulation	R_{egL}	$I_O=5mA$ to $4.6A$	-	0.5	2.0	%
Line regulation	R_{egI}	$V_{IN}=4$ to $10V$	-	0.5	2.5	%
Reference voltage	V_{ref}	-	1.225	1.25	1.275	V
Temperature coefficient of reference voltage	$T_C V_{ref}$	$T_j=0$ to $125^\circ C$	-	± 0.01	-	%/°C
Ripple rejection	RR	-	45	55	-	dB
Dropout voltage(1)	$V_{I-O(1)}$	^{*4} , $I_O=4.0A$	-	-	0.5	V
Dropout voltage(2)	$V_{I-O(2)}$	^{*4} , $I_O=4.6A$	-	-	1.0	V
Quiescent current	I_q	$I_O=0A$	-	-	17	mA

*4 Input voltage shall be the value when output voltage is 95% in comparison with the initial value.

Fig.1 Test Circuit

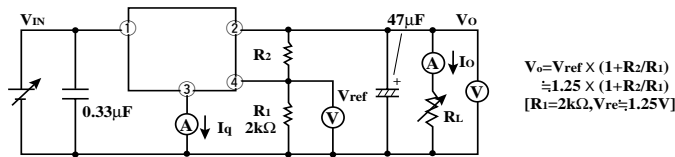

Fig.2 Test circuit for Ripple Rejection

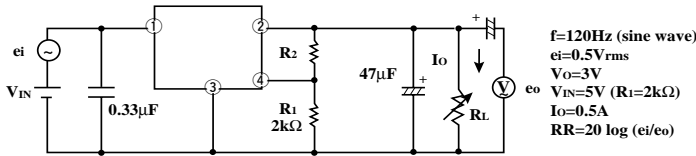

Fig.3 Power Dissipation vs. Ambient Temperature

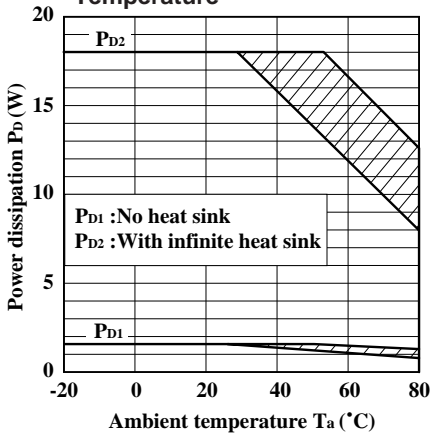
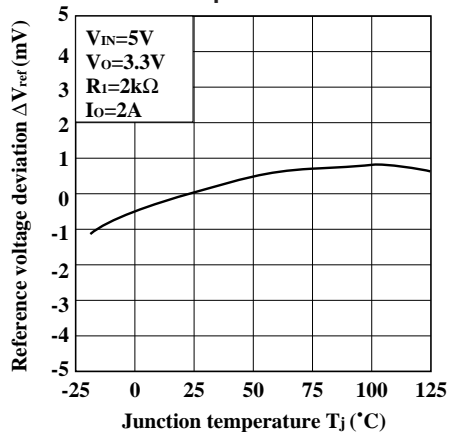

Fig.4 Reference Voltage Deviation vs. Junction Temperature



Note) Oblique line portion: Overheat protection may operate in this area.

Fig.5 Relative Output Voltage vs. Output Current (Typical Value)

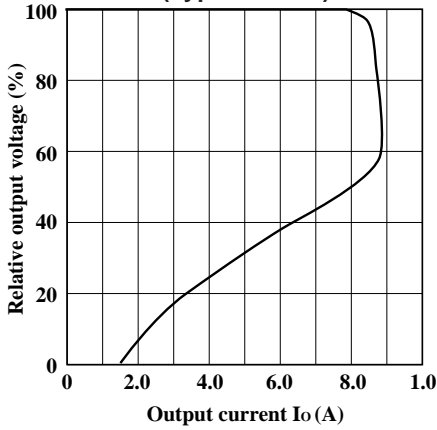

Fig.6 Output Voltage vs. Input Voltage

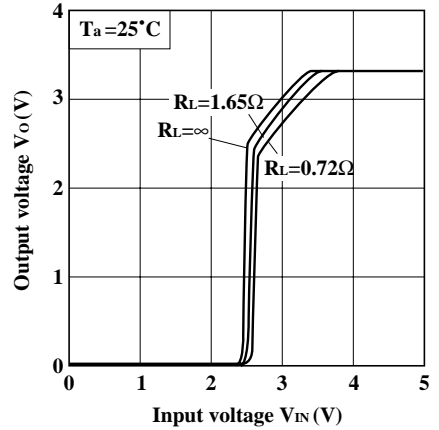

Fig.7 Circuit Operating Current vs. Input Voltage

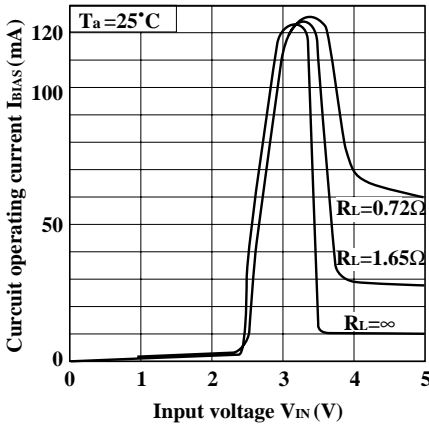

Fig.8 Dropout Voltage vs. Junction Temperature

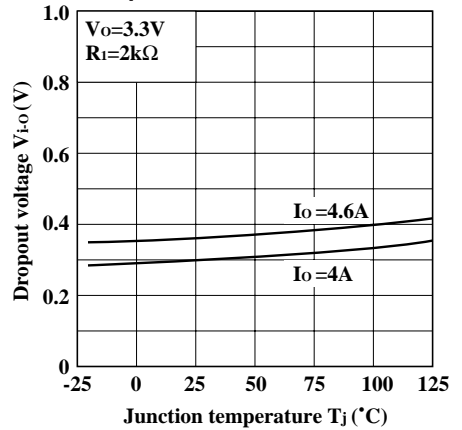

Fig.9 Quiescent Current vs. Junction Temperature

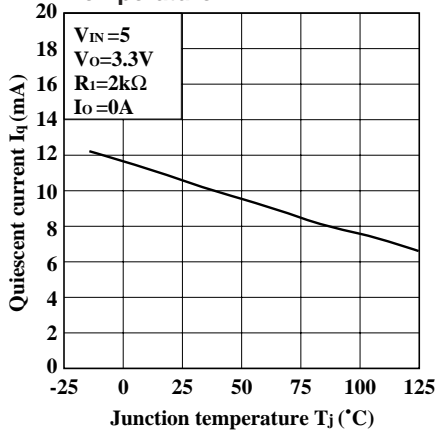
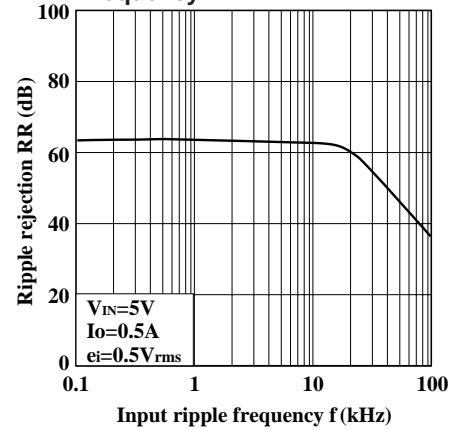
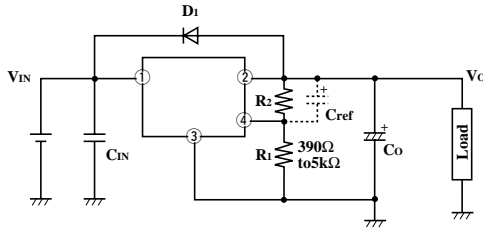

Fig.10 Ripple Rejection vs. Input Ripple Frequency



Standard Connection



D1 : This device is necessary to protect the element from damage when reverse voltage may be applied to the regulator in case of input short-circuiting.

Cref : This device is necessary when it is required to enhance the ripple rejection or to delay the output start-up time. Otherwise, it is not necessary.

(Care must be taken since Cref may raise the gain, facilitating oscillation.)

* The output start-up time is proportional to Cref X R2.

CIN, Co : Be sure to mount the devices CIN and Co as close to the device terminal as possible so as to prevent oscillation.

The standard specification of CIN and Co is 0.33μF and 47μF, respectively. However, adjust them as necessary after checking.

R1, R2 : These devices are necessary to set the output voltage. The output voltage VO is given by the following formula:

$$V_o = V_{ref} \times (1 + R_2/R_1)$$

(Vref is 1.25V TYP)

The standard value of R1 is 2kΩ. But value up to 390Ω to 5kΩ does not cause any trouble.

Adjustment of Output Voltage

Output voltage is able to set (1.5V to 7V) when resistors R1, R2 are attached to ②, ③, ④ terminals. As for the external resistors to set output voltage, refer to the following figure.

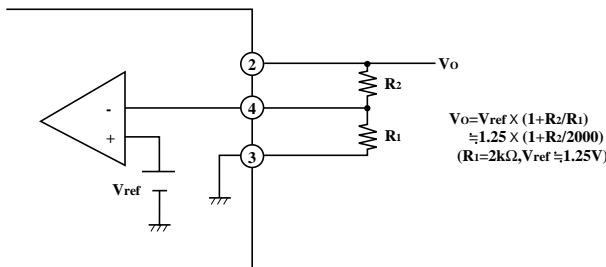

ON/OFF Operation

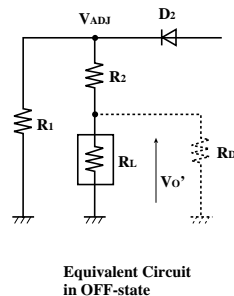
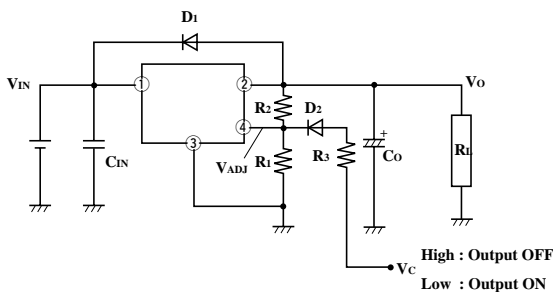

ON/OFF operation is available by mounting externally D_2 and R_3 .

When V_{ADJ} is forcibly raised above V_{ref} (1.25V TYP) by applying the external signal, the output is turned off (pass transistor of regulator is turned off). When the output is OFF, V_{ADJ} must be higher than $V_{ref MAX.}$, and at the same time must be lower than maximum rating 5V.

In OFF-state, the load current flows to R_L from V_{ADJ} through R_2 . Therefore the value of R_2 must be as high as possible.

In OFF state, as shown below, voltage

$$V_O' = V_{ADJ} \times R_L / (R_L + R_2)$$

occurs at the load. OFF-state equivalent circuit R_1 up to $5k\Omega$ is allowed.

Select as high value of R_L and R_2 as possible in this range. In some case, as output voltage is getting lower ($V_O < 1V$), impedance of load resistance rises. In such condition, it is sometimes impossible to obtain the minimum value of V_O' . So add the dummy resistance indicated by R_D in the figure to the circuit parallel to the load.

NOTICE

- The circuit application examples in this publication are provided to explain representative applications of SHARP devices and are not intended to guarantee any circuit design or license any intellectual property rights. SHARP takes no responsibility for any problems related to any intellectual property right of a third party resulting from the use of SHARP's devices.
- Contact SHARP in order to obtain the latest device specification sheets before using any SHARP device. SHARP reserves the right to make changes in the specifications, characteristics, data, materials, structure, and other contents described herein at any time without notice in order to improve design or reliability. Manufacturing locations are also subject to change without notice.
- Observe the following points when using any devices in this publication. SHARP takes no responsibility for damage caused by improper use of the devices which does not meet the conditions and absolute maximum ratings to be used specified in the relevant specification sheet nor meet the following conditions:
 - (i) The devices in this publication are designed for use in general electronic equipment designs such as:
 - Personal computers
 - Office automation equipment
 - Telecommunication equipment [terminal]
 - Test and measurement equipment
 - Industrial control
 - Audio visual equipment
 - Consumer electronics
 - (ii) Measures such as fail-safe function and redundant design should be taken to ensure reliability and safety when SHARP devices are used for or in connection with equipment that requires higher reliability such as:
 - Transportation control and safety equipment (i.e., aircraft, trains, automobiles, etc.)
 - Traffic signals
 - Gas leakage sensor breakers
 - Alarm equipment
 - Various safety devices, etc.
 - (iii) SHARP devices shall not be used for or in connection with equipment that requires an extremely high level of reliability and safety such as:
 - Space applications
 - Telecommunication equipment [trunk lines]
 - Nuclear power control equipment
 - Medical and other life support equipment (e.g., scuba).
- Contact a SHARP representative in advance when intending to use SHARP devices for any "specific" applications other than those recommended by SHARP or when it is unclear which category mentioned above controls the intended use.
- If the SHARP devices listed in this publication fall within the scope of strategic products described in the Foreign Exchange and Foreign Trade Control Law of Japan, it is necessary to obtain approval to export such SHARP devices.
- This publication is the proprietary product of SHARP and is copyrighted, with all rights reserved. Under the copyright laws, no part of this publication may be reproduced or transmitted in any form or by any means, electronic or mechanical, for any purpose, in whole or in part, without the express written permission of SHARP. Express written permission is also required before any use of this publication may be made by a third party.
- Contact and consult with a SHARP representative if there are any questions about the contents of this publication.