

# NLSX4401

## 1-Bit 20 Mb/s Dual-Supply Level Translator

The NLSX4401 is a 1-bit configurable dual-supply bidirectional auto sensing translator that does not require a directional control pin. The I/O  $V_{CC}$  and I/O  $V_L$  ports are designed to track two different power supply rails,  $V_{CC}$  and  $V_L$  respectively. Both the  $V_{CC}$  and  $V_L$  supply rails are configurable from 1.5 V to 5.5 V. This allows voltage logic signals on the  $V_L$  side to be translated into lower, higher or equal value voltage logic signals on the  $V_{CC}$  side, and vice-versa.

The NLSX4401 translator has integrated 10 k $\Omega$  pull-up resistors on the I/O lines. The integrated pull-up resistors are used to pull up the I/O lines to either  $V_L$  or  $V_{CC}$ . The NLSX4401 is an excellent match for open-drain applications such as the I<sup>2</sup>C communication bus.

### Features

- $V_L$  can be Less than, Greater than or Equal to  $V_{CC}$
- Wide  $V_{CC}$  Operating Range: 1.5 V to 5.5 V  
Wide  $V_L$  Operating Range: 1.5 V to 5.5 V
- High Speed with 24 Mb/s Guaranteed Data Rate
- Low Bit-to-Bit Skew
- Enable Input and I/O Pins are Overvoltage Tolerant (OVT) to 5.5 V
- Non-preferential Powerup Sequencing
- Power-Off Protection
- Integrated 10 k $\Omega$  Pull-up Resistors
- Small Space Saving Package:  
1.45 mm x 1.0 mm UDFN6 Package
- These Devices are Pb-Free and are RoHS Compliant

### Typical Applications

- I<sup>2</sup>C, SMBus, PMBus
- Low Voltage ASIC Level Translation
- Mobile Phones, PDAs, Cameras

### Important Information

- ESD Protection for All Pins
  - Human Body Model (HBM) > 5000 V



ON Semiconductor®

[www.onsemi.com](http://www.onsemi.com)



UDFN6  
1.45 x 1.0  
CASE 517AQ

### MARKING DIAGRAM



Y = Specific Device Code  
(Rotated 270° clockwise)  
M = Date Code

### LOGIC DIAGRAM

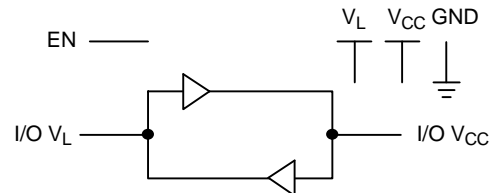

### ORDERING INFORMATION

Device	Package	Shipping†
NLSX4401MU1TCG	UDFN6 (Pb-Free)	3000 / Tape & Reel

†For information on tape and reel specifications, including part orientation and tape sizes, please refer to our Tape and Reel Packaging Specification Brochure, BRD8011/D.

# NLSX4401

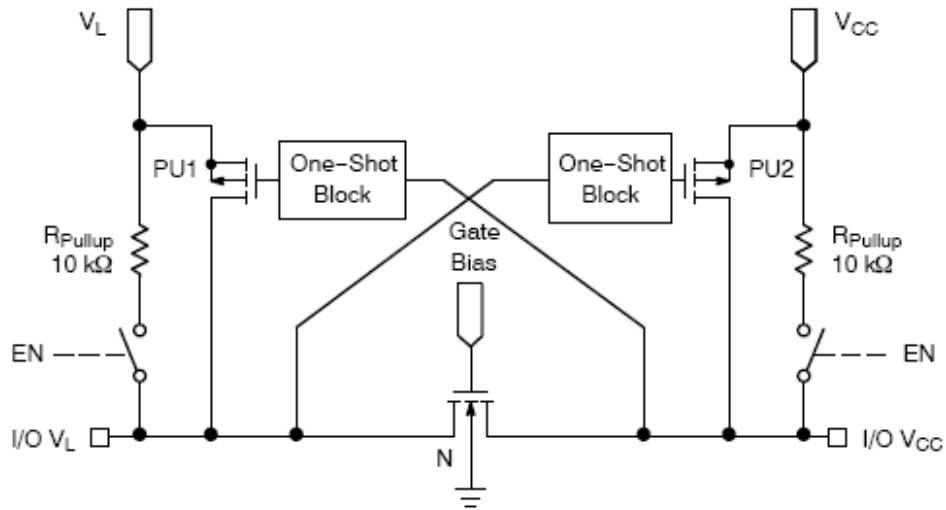
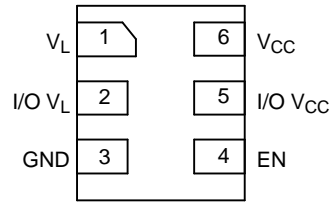

Figure 1. Block Diagram (1 I/O Line)



UDFN6  
(Top Through View)

Figure 2. Pinout Diagram

## PIN ASSIGNMENT

Pins	Description
V <sub>CC</sub>	V <sub>CC</sub> Supply Voltage
V <sub>L</sub>	V <sub>L</sub> Supply Voltage
GND	Ground
EN	Output Enable, Referenced to V <sub>L</sub>
I/O V <sub>CC</sub>	I/O Port, Referenced to V <sub>CC</sub>
I/O V <sub>L</sub>	I/O Port, Referenced to V <sub>L</sub>

## FUNCTION TABLE

EN	Operating Mode
L	Hi-Z
H	I/O Buses Connected

# NLSX4401

## MAXIMUM RATINGS

Symbol	Parameter	Value	Condition	Unit
V <sub>CC</sub>	High-side DC Supply Voltage	-0.5 to +7.0		V
V <sub>L</sub>	High-side DC Supply Voltage	-0.5 to +7.0		V
I/O V <sub>CC</sub>	V <sub>CC</sub> -Referenced DC Input/Output Voltage	-0.5 to +7.0		V
I/O V <sub>L</sub>	V <sub>L</sub> -Referenced DC Input/Output Voltage	-0.5 to +7.0		V
V <sub>EN</sub>	Enable Control Pin DC Input Voltage	-0.5 to +7.0		V
I <sub>I/O_SC</sub>	Short-Circuit Duration (I/O V <sub>L</sub> and I/O V <sub>CC</sub> to GND)	±50	Continuous	mA
I <sub>I/O_K</sub>	Input/Output Clamping Current (I/O V <sub>L</sub> and I/O V <sub>CC</sub> )	-50	V <sub>I/O</sub> < 0	mA
T <sub>STG</sub>	Storage Temperature	-65 to +150		°C

Stresses exceeding those listed in the Maximum Ratings table may damage the device. If any of these limits are exceeded, device functionality should not be assumed, damage may occur and reliability may be affected.

## RECOMMENDED OPERATING CONDITIONS

Symbol	Parameter	Min	Max	Unit
V <sub>CC</sub>	High-side Positive DC Supply Voltage	1.5	5.5	V
V <sub>L</sub>	High-side Positive DC Supply Voltage	1.5	5.5	V
V <sub>EN</sub>	Enable Control Pin Voltage	GND	5.5	V
V <sub>IO_VCC</sub>	I/O Pin Voltage (Side referred to V <sub>CC</sub> )	GND	5.5	V
V <sub>IO_VL</sub>	I/O Pin Voltage (Side referred to V <sub>L</sub> )	GND	5.5	V
Δt/ΔV	Input Transition Rise and Fall Rate A- or B-Ports, Push-Pull Driving Control Input		10 10	ns/V
T <sub>A</sub>	Operating Temperature Range	-55	+125	°C

Functional operation above the stresses listed in the Recommended Operating Ranges is not implied. Extended exposure to stresses beyond the Recommended Operating Ranges limits may affect device reliability.

# NLSX4401

## DC ELECTRICAL CHARACTERISTICS ( $V_L = 1.5\text{ V to }5.5\text{ V}$ and $V_{CC} = 1.5\text{ V to }5.5\text{ V}$ , unless otherwise specified) (Note 1)

Symbol	Parameter	Test Conditions (Note 2)	-55°C to +125°C			Unit
			Min	Typ	Max	
$V_{IHC}$	I/O $V_{CC}$ Input HIGH Voltage		$V_{CC} - 0.4$	-	-	V
$V_{ILC}$	I/O $V_{CC}$ Input LOW Voltage		-	-	0.15	V
$V_{IHL}$	I/O $V_L$ Input HIGH Voltage		$V_L - 0.4$	-	-	V
$V_{ILL}$	I/O $V_L$ Input LOW Voltage		-	-	0.15	V
$V_{IH}$	Control Pin Input HIGH Voltage		$0.65 * V_L$	-	-	V
$V_{IL}$	Control Pin Input LOW Voltage		-	-	$0.35 * V_L$	V
$V_{OHC}$	I/O $V_{CC}$ Output HIGH Voltage	I/O $V_{CC}$ source current = 20 $\mu\text{A}$	$2/3 * V_{CC}$	-	-	V
$V_{OLC}$	I/O $V_{CC}$ Output LOW Voltage	I/O $V_{CC}$ sink current = 1 mA	-	-	0.4	V
$V_{OHL}$	I/O $V_L$ Output HIGH Voltage	I/O $V_L$ source current = 20 $\mu\text{A}$	$2/3 * V_L$	-	-	V
$V_{OLL}$	I/O $V_L$ Output LOW Voltage	I/O $V_L$ sink current = 1 mA	-	-	0.4	V
$I_{QVCC}$	$V_{CC}$ Supply Current Supply Current	I/O $V_{CC}$ and I/O $V_L$ unconnected, $V_{EN} = V_L$	-	0.5	2.0	$\mu\text{A}$
		$V_L = 5.5\text{ V}$ , $V_{CC} = 0\text{ V}$	-	-	1.0	
		$V_L = 0\text{ V}$ , $V_{CC} = 5.5\text{ V}$	-	-	-1.0	
$I_{QVL}$	$V_L$ Supply Current Supply Current	I/O $V_{CC}$ and I/O $V_L$ unconnected, $V_{EN} = V_L$	-	0.3	1.5	$\mu\text{A}$
		$V_L = 5.5\text{ V}$ , $V_{CC} = 0\text{ V}$	-	-	-1.0	
		$V_L = 0\text{ V}$ , $V_{CC} = 5.5\text{ V}$	-	-	1.0	
$I_{TS-VCC}$	$V_{CC}$ Tristate Output Mode	I/O $V_{CC}$ and I/O $V_L$ unconnected, $V_{EN} = \text{GND}$	-	0.1	1.0	$\mu\text{A}$
$I_{TS-VL}$	$V_L$ Tristate Output Mode Supply Current	I/O $V_{CC}$ and I/O $V_L$ unconnected, $V_{EN} = \text{GND}$	-	0.1	1.0	$\mu\text{A}$
$I_I$	Enable Pin Input Leakage Current		-	-	1.0	$\mu\text{A}$
$I_{OFF}$	I/O Power-Off Leakage Current	I/O $V_{CC}$ Port, $V_{CC} = 0\text{ V}$ , $V_L = 0\text{ to }5.5\text{ V}$	-	-	1.0	$\mu\text{A}$
		I/O $V_L$ Port, $V_{CC} = 0\text{ to }5.5\text{ V}$ , $V_L = 0\text{ V}$	-	-	1.0	
$I_{OZ}$	I/O Tristate Output Mode Leakage Current		-	0.1	1.0	$\mu\text{A}$
$R_{PU}$	Pull-Up Resistors I/O $V_L$ and $V_C$		-	10	-	$\text{k}\Omega$

Product parametric performance is indicated in the Electrical Characteristics for the listed test conditions, unless otherwise noted. Product performance may not be indicated by the Electrical Characteristics if operated under different conditions.

1. Typical values are for  $V_L = +1.8\text{ V}$ ,  $V_{CC} = +3.3\text{ V}$  and  $T_A = +25^\circ\text{C}$ .

2. All units are production tested at  $T_A = +25^\circ\text{C}$ . Limits over the operating temperature range are guaranteed by design.

# NLSX4401

## TIMING CHARACTERISTICS – RAIL-TO-RAIL DRIVING CONFIGURATIONS

(I/O test circuit of Figures 3 and 4,  $C_{LOAD} = 15 \text{ pF}$ , driver output impedance  $\leq 50 \Omega$ ,  $R_{LOAD} = 1 \text{ M}\Omega$ )

Symbol	Parameter	Test Conditions	-40°C to +85°C (Notes 3 & 4)			Unit
			Min	Typ	Max	

### $V_L = 1.5 \text{ V}$ , $V_{CC} = 1.5 \text{ V}$

$t_{RVCC}$	I/O $V_{CC}$ Rise Time			9	32	ns
$t_{FVCC}$	I/O $V_{CC}$ Fall Time			11	20	ns
$t_{RVL}$	I/O $V_L$ Rise Time			20	30	ns
$t_{FVL}$	I/O $V_L$ Fall Time			10	13	ns
$t_{PDVL-VCC}$	Propagation Delay (Driving I/O $V_L$ , $V_L$ to $V_{CC}$ )			7	16	ns
$t_{PDVCC-VL}$	Propagation Delay (Driving I/O $V_{CC}$ , $V_{CC}$ to $V_L$ )			12	15	ns
$t_{EN}$	Enable Time				50	ns
$t_{DIS}$	Disable Time				300	ns
$t_{PPSKEW}$	Part-to-Part Skew				2	ns
MDR	Maximum Data Rate		15			Mbps

### $V_L = 1.5 \text{ V}$ , $V_{CC} = 5.5 \text{ V}$

$t_{RVCC}$	I/O $V_{CC}$ Rise Time			9	12	ns
$t_{FVCC}$	I/O $V_{CC}$ Fall Time			17	30	ns
$t_{RVL}$	I/O $V_L$ Rise Time			2	4	ns
$t_{FVL}$	I/O $V_L$ Fall Time			3	7	ns
$t_{PDVL-VCC}$	Propagation Delay (Driving I/O $V_L$ , $V_L$ to $V_{CC}$ )			14	24	ns
$t_{PDVCC-VL}$	Propagation Delay (Driving I/O $V_{CC}$ , $V_{CC}$ to $V_L$ )			3	5	ns
$t_{EN}$	Enable Time				40	ns
$t_{DIS}$	Disable Time				250	ns
$t_{PPSKEW}$	Part-to-Part Skew				2	ns
MDR	Maximum Data Rate		20			Mbps

### $V_L = 1.8 \text{ V}$ , $V_{CC} = 2.8 \text{ V}$

$t_{RVCC}$	I/O $V_{CC}$ Rise Time			11	18	ns
$t_{FVCC}$	I/O $V_{CC}$ Fall Time			10	15	ns
$t_{RVL}$	I/O $V_L$ Rise Time			12	15	ns
$t_{FVL}$	I/O $V_L$ Fall Time			5	8	ns
$t_{PDVL-VCC}$	Propagation Delay (Driving I/O $V_L$ , $V_L$ to $V_{CC}$ )			7	10	ns
$t_{PDVCC-VL}$	Propagation Delay (Driving I/O $V_{CC}$ , $V_{CC}$ to $V_L$ )			5	9	ns
$t_{EN}$	Enable Time				50	ns
$t_{DIS}$	Disable Time				300	ns
$t_{PPSKEW}$	Part-to-Part Skew				2	ns
MDR	Maximum Data Rate		20			Mbps

### $V_L = 2.5 \text{ V}$ , $V_{CC} = 3.6 \text{ V}$

$t_{RVCC}$	I/O $V_{CC}$ Rise Time			8	12	ns
------------	------------------------	--	--	---	----	----

Product parametric performance is indicated in the Electrical Characteristics for the listed test conditions, unless otherwise noted. Product performance may not be indicated by the Electrical Characteristics if operated under different conditions.

3. Typical values are for the specified  $V_L$  and  $V_{CC}$  at  $T_A = +25^\circ\text{C}$ . All units are production tested at  $T_A = +25^\circ\text{C}$ .

4. Limits over the operating temperature range are guaranteed by design.

5. Skew is the variation of propagation delay between output signals and applies only to output signals on the same port (I/O\_VLn or I/O\_VCCn) and switching with the same polarity (LOW-to-HIGH or HIGH-to-LOW). Skew is defined by applying a single input to the two input channels and measuring the difference in propagation delays between the output channels.

# NLSX4401

## TIMING CHARACTERISTICS – RAIL-TO-RAIL DRIVING CONFIGURATIONS (continued)

(I/O test circuit of Figures 3 and 4,  $C_{LOAD} = 15 \text{ pF}$ , driver output impedance  $\leq 50 \Omega$ ,  $R_{LOAD} = 1 \text{ M}\Omega$ )

Symbol	Parameter	Test Conditions	-40°C to +85°C (Notes 3 & 4)			Unit
			Min	Typ	Max	

**$V_L = 2.5 \text{ V}$ ,  $V_{CC} = 3.6 \text{ V}$**

$t_{FVCC}$	I/O $V_{CC}$ Fall Time			8	12	ns
$t_{RVL}$	I/O $V_L$ Rise Time			7	10	ns
$t_{FVL}$	I/O $V_L$ Fall Time			5	7	ns
$t_{PDVL-VCC}$	Propagation Delay (Driving I/O $V_L$ , $V_L$ to $V_{CC}$ )			7	10	ns
$t_{PDVCC-VL}$	Propagation Delay (Driving I/O $V_{CC}$ , $V_{CC}$ to $V_L$ )			5	8	ns
$t_{EN}$	Enable Time				40	ns
$t_{DIS}$	Disable Time				225	ns
$t_{PPSKEW}$	Part-to-Part Skew				2	ns
MDR	Maximum Data Rate		24			Mbps

**$V_L = 2.8 \text{ V}$ ,  $V_{CC} = 1.8 \text{ V}$**

$t_{RVCC}$	I/O $V_{CC}$ Rise Time			13	20	ns
$t_{FVCC}$	I/O $V_{CC}$ Fall Time			7	10	ns
$t_{RVL}$	I/O $V_L$ Rise Time			8	13	ns
$t_{FVL}$	I/O $V_L$ Fall Time			9	15	ns
$t_{PDVL-VCC}$	Propagation Delay (Driving I/O $V_L$ , $V_L$ to $V_{CC}$ )			6	9	ns
$t_{PDVCC-VL}$	Propagation Delay (Driving I/O $V_{CC}$ , $V_{CC}$ to $V_L$ )			7	12	ns
$t_{EN}$	Enable Time				60	ns
$t_{DIS}$	Disable Time				250	ns
$t_{PPSKEW}$	Part-to-Part Skew				2	ns
MDR	Maximum Data Rate		24			Mbps

**$V_L = 3.6 \text{ V}$ ,  $V_{CC} = 2.5 \text{ V}$**

$t_{RVCC}$	I/O $V_{CC}$ Rise Time			9	12	ns
$t_{FVCC}$	I/O $V_{CC}$ Fall Time			6	9	ns
$t_{RVL}$	I/O $V_L$ Rise Time			6	12	ns
$t_{FVL}$	I/O $V_L$ Fall Time			7	12	ns
$t_{PDVL-VCC}$	Propagation Delay (Driving I/O $V_L$ , $V_L$ to $V_{CC}$ )			5	7	ns
$t_{PDVCC-VL}$	Propagation Delay (Driving I/O $V_{CC}$ , $V_{CC}$ to $V_L$ )			6	9	ns
$t_{EN}$	Enable Time				50	ns
$t_{DIS}$	Disable Time				250	ns
$t_{PPSKEW}$	Part-to-Part Skew				2	ns
MDR	Maximum Data Rate		24			Mbps

**$V_L = 5.5 \text{ V}$ ,  $V_{CC} = 1.5 \text{ V}$**

$t_{RVCC}$	I/O $V_{CC}$ Rise Time			13	20	ns
$t_{FVCC}$	I/O $V_{CC}$ Fall Time			6	9	ns

Product parametric performance is indicated in the Electrical Characteristics for the listed test conditions, unless otherwise noted. Product performance may not be indicated by the Electrical Characteristics if operated under different conditions.

3. Typical values are for the specified  $V_L$  and  $V_{CC}$  at  $T_A = +25^\circ\text{C}$ . All units are production tested at  $T_A = +25^\circ\text{C}$ .

4. Limits over the operating temperature range are guaranteed by design.

5. Skew is the variation of propagation delay between output signals and applies only to output signals on the same port (I/O\_VLn or I/O\_VCCn) and switching with the same polarity (LOW-to-HIGH or HIGH-to-LOW). Skew is defined by applying a single input to the two input channels and measuring the difference in propagation delays between the output channels.

# NLSX4401

## TIMING CHARACTERISTICS – RAIL-TO-RAIL DRIVING CONFIGURATIONS (continued)

(I/O test circuit of Figures 3 and 4,  $C_{LOAD} = 15 \text{ pF}$ , driver output impedance  $\leq 50 \Omega$ ,  $R_{LOAD} = 1 \text{ M}\Omega$ )

Symbol	Parameter	Test Conditions	-40°C to +85°C (Notes 3 & 4)			Unit
			Min	Typ	Max	
<b><math>V_L = 5.5 \text{ V}</math>, <math>V_{CC} = 1.5 \text{ V}</math></b>						
$t_{rVL}$	I/O $V_L$ Rise Time			8	10	ns
$t_{fVL}$	I/O $V_L$ Fall Time			20	27	ns
$t_{PDVL-VCC}$	Propagation Delay (Driving I/O $V_L$ , $V_L$ to $V_{CC}$ )			5	8	ns
$t_{PDVCC-VL}$	Propagation Delay (Driving I/O $V_{CC}$ , $V_{CC}$ to $V_L$ )			14	24	ns
$t_{EN}$	Enable Time					ns
$t_{DIS}$	Disable Time					ns
$t_{PPSKEW}$	Part-to-Part Skew				2	ns
MDR	Maximum Data Rate		20			Mbps

**$V_L = 5.5 \text{ V}$ ,  $V_{CC} = 5.5 \text{ V}$**

$t_{rVCC}$	I/O $V_{CC}$ Rise Time			5	7	ns
$t_{fVCC}$	I/O $V_{CC}$ Fall Time			6	8	ns
$t_{rVL}$	I/O $V_L$ Rise Time			5	7	ns
$t_{fVL}$	I/O $V_L$ Fall Time			4	7	ns
$t_{PDVL-VCC}$	Propagation Delay (Driving I/O $V_L$ , $V_L$ to $V_{CC}$ )			4	6	ns
$t_{PDVCC-VL}$	Propagation Delay (Driving I/O $V_{CC}$ , $V_{CC}$ to $V_L$ )			4	6	ns
$t_{EN}$	Enable Time				30	ns
$t_{DIS}$	Disable Time				225	ns
$t_{PPSKEW}$	Part-to-Part Skew				2	ns
MDR	Maximum Data Rate		24			Mbps

Product parametric performance is indicated in the Electrical Characteristics for the listed test conditions, unless otherwise noted. Product performance may not be indicated by the Electrical Characteristics if operated under different conditions.

3. Typical values are for the specified  $V_L$  and  $V_{CC}$  at  $T_A = +25^\circ\text{C}$ . All units are production tested at  $T_A = +25^\circ\text{C}$ .

4. Limits over the operating temperature range are guaranteed by design.

5. Skew is the variation of propagation delay between output signals and applies only to output signals on the same port (I/O\_VL<sub>n</sub> or I/O\_VCC<sub>n</sub>) and switching with the same polarity (LOW-to-HIGH or HIGH-to-LOW). Skew is defined by applying a single input to the two input channels and measuring the difference in propagation delays between the output channels.

## TIMING CHARACTERISTICS – OPEN DRAIN DRIVING CONFIGURATIONS

(I/O test circuit of Figures 5 and 6,  $C_{LOAD} = 15 \text{ pF}$ , driver output impedance  $\leq 50 \Omega$ ,  $R_{LOAD} = 1 \text{ M}\Omega$ )

Symbol	Parameter	Test Conditions	-40°C to +85°C (Notes 6 & 7)			Unit
			Min	Typ	Max	

**$V_L = 1.5 \text{ V}$ ,  $V_{CC} = 1.5 \text{ V}$**

$t_{rVCC}$	I/O $V_{CC}$ Rise Time			55	70	ns
$t_{fVCC}$	I/O $V_{CC}$ Fall Time			7	14	ns
$t_{rVL}$	I/O $V_L$ Rise Time			50	65	ns
$t_{fVL}$	I/O $V_L$ Fall Time			7	12	ns

Product parametric performance is indicated in the Electrical Characteristics for the listed test conditions, unless otherwise noted. Product performance may not be indicated by the Electrical Characteristics if operated under different conditions.

6. Typical values are for the specified  $V_L$  and  $V_{CC}$  at  $T_A = +25^\circ\text{C}$ . All units are production tested at  $T_A = +25^\circ\text{C}$ .

7. Limits over the operating temperature range are guaranteed by design.

8. Skew is the variation of propagation delay between output signals and applies only to output signals on the same port (I/O\_VL<sub>n</sub> or I/O\_VCC<sub>n</sub>) and switching with the same polarity (LOW-to-HIGH or HIGH-to-LOW). Skew is defined by applying a single input to the two input channels and measuring the difference in propagation delays between the output channels.

# NLSX4401

## TIMING CHARACTERISTICS – OPEN DRAIN DRIVING CONFIGURATIONS (continued)

(I/O test circuit of Figures 5 and 6,  $C_{LOAD} = 15 \text{ pF}$ , driver output impedance  $\leq 50 \Omega$ ,  $R_{LOAD} = 1 \text{ M}\Omega$ )

Symbol	Parameter	Test Conditions	–40°C to +85°C (Notes 6 & 7)			Unit
			Min	Typ	Max	

$V_L = 1.5 \text{ V}$ ,  $V_{CC} = 1.5 \text{ V}$

$t_{PDVL-VCC}$	Propagation Delay (Driving I/O $V_L$ , $V_L$ to $V_{CC}$ )		20	34	ns
$t_{PDVCC-VL}$	Propagation Delay (Driving I/O $V_{CC}$ , $V_{CC}$ to $V_L$ )		19	34	ns
$t_{EN}$	Enable Time			100	ns
$t_{DIS}$	Disable Time			300	ns
$t_{PPSKEW}$	Part-to-Part Skew			2	ns
MDR	Maximum Data Rate	3			Mbps

$V_L = 1.5 \text{ V}$ ,  $V_{CC} = 5.5 \text{ V}$

$t_{RVCC}$	I/O $V_{CC}$ Rise Time		22	34	ns
$t_{FVCC}$	I/O $V_{CC}$ Fall Time		20	27	ns
$t_{RVL}$	I/O $V_L$ Rise Time		43	55	ns
$t_{FVL}$	I/O $V_L$ Fall Time		6	12	ns
$t_{PDVL-VCC}$	Propagation Delay (Driving I/O $V_L$ , $V_L$ to $V_{CC}$ )		13	26	ns
$t_{PDVCC-VL}$	Propagation Delay (Driving I/O $V_{CC}$ , $V_{CC}$ to $V_L$ )		19	24	ns
$t_{EN}$	Enable Time			80	ns
$t_{DIS}$	Disable Time			250	ns
$t_{PPSKEW}$	Part-to-Part Skew			2	ns
MDR	Maximum Data Rate	3			Mbps

$V_L = 1.8 \text{ V}$ ,  $V_{CC} = 3.3 \text{ V}$

$t_{RVCC}$	I/O $V_{CC}$ Rise Time		34	40	ns
$t_{FVCC}$	I/O $V_{CC}$ Fall Time		1	15	ns
$t_{RVL}$	I/O $V_L$ Rise Time		40	48	ns
$t_{FVL}$	I/O $V_L$ Fall Time		1	2	ns
$t_{PDVL-VCC}$	Propagation Delay (Driving I/O $V_L$ , $V_L$ to $V_{CC}$ )		9	15	ns
$t_{PDVCC-VL}$	Propagation Delay (Driving I/O $V_{CC}$ , $V_{CC}$ to $V_L$ )		6	11	ns
$t_{EN}$	Enable Time			70	ns
$t_{DIS}$	Disable Time			300	ns
$t_{PPSKEW}$	Part-to-Part Skew			2	ns
MDR	Maximum Data Rate	7			Mbps

$V_L = 5.5 \text{ V}$ ,  $V_{CC} = 1.5 \text{ V}$

$t_{RVCC}$	I/O $V_{CC}$ Rise Time		44	52	ns
$t_{FVCC}$	I/O $V_{CC}$ Fall Time		1	2	ns
$t_{RVL}$	I/O $V_L$ Rise Time		7	30	ns
$t_{FVL}$	I/O $V_L$ Fall Time		17	23	ns
$t_{PDVL-VCC}$	Propagation Delay (Driving I/O $V_L$ , $V_L$ to $V_{CC}$ )		10	17	ns

Product parametric performance is indicated in the Electrical Characteristics for the listed test conditions, unless otherwise noted. Product performance may not be indicated by the Electrical Characteristics if operated under different conditions.

6. Typical values are for the specified  $V_L$  and  $V_{CC}$  at  $T_A = +25^\circ\text{C}$ . All units are production tested at  $T_A = +25^\circ\text{C}$ .

7. Limits over the operating temperature range are guaranteed by design.

8. Skew is the variation of propagation delay between output signals and applies only to output signals on the same port (I/O\_VLn or I/O\_VCCn) and switching with the same polarity (LOW-to-HIGH or HIGH-to-LOW). Skew is defined by applying a single input to the two input channels and measuring the difference in propagation delays between the output channels.



# NLSX4401

## TIMING CHARACTERISTICS – OPEN DRAIN DRIVING CONFIGURATIONS (continued)

(I/O test circuit of Figures 5 and 6,  $C_{LOAD} = 15 \text{ pF}$ , driver output impedance  $\leq 50 \Omega$ ,  $R_{LOAD} = 1 \text{ M}\Omega$ )

Symbol	Parameter	Test Conditions	–40°C to +85°C (Notes 6 & 7)			Unit
			Min	Typ	Max	

$V_L = 5.5 \text{ V}$ ,  $V_{CC} = 1.5 \text{ V}$

$t_{PDVCC-VL}$	Propagation Delay (Driving I/O $V_{CC}$ , $V_{CC}$ to $V_L$ )			12	24	ns
$t_{EN}$	Enable Time				100	ns
$t_{DIS}$	Disable Time				300	ns
$t_{PPSKEW}$	Part-to-Part Skew				2	ns
MDR	Maximum Data Rate		3			Mbps

$V_L = 5.5 \text{ V}$ ,  $V_{CC} = 5.5 \text{ V}$

$t_{RVCC}$	I/O $V_{CC}$ Rise Time			42	50	ns
$t_{FVCC}$	I/O $V_{CC}$ Fall Time			2	3	ns
$t_{RVL}$	I/O $V_L$ Rise Time			44	48	ns
$t_{FVL}$	I/O $V_L$ Fall Time			2	3	ns
$t_{PDVL-VCC}$	Propagation Delay (Driving I/O $V_L$ , $V_L$ to $V_{CC}$ )			4	6	ns
$t_{PDVCC-VL}$	Propagation Delay (Driving I/O $V_{CC}$ , $V_{CC}$ to $V_L$ )			6	9	ns
$t_{EN}$	Enable Time				60	ns
$t_{DIS}$	Disable Time				225	ns
$t_{PPSKEW}$	Part-to-Part Skew				2	ns
MDR	Maximum Data Rate		7			Mbps

Product parametric performance is indicated in the Electrical Characteristics for the listed test conditions, unless otherwise noted. Product performance may not be indicated by the Electrical Characteristics if operated under different conditions.

6. Typical values are for the specified  $V_L$  and  $V_{CC}$  at  $T_A = +25^\circ\text{C}$ . All units are production tested at  $T_A = +25^\circ\text{C}$ .

7. Limits over the operating temperature range are guaranteed by design.

8. Skew is the variation of propagation delay between output signals and applies only to output signals on the same port (I/O\_VLn or I/O\_VCCn) and switching with the same polarity (LOW-to-HIGH or HIGH-to-LOW). Skew is defined by applying a single input to the two input channels and measuring the difference in propagation delays between the output channels.

# NLSX4401

## TEST SETUP

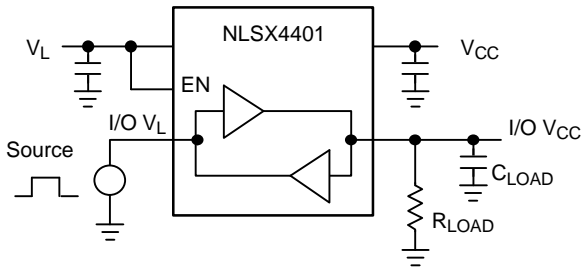

Figure 3. Rail-to-Rail Driving I/O  $V_L$

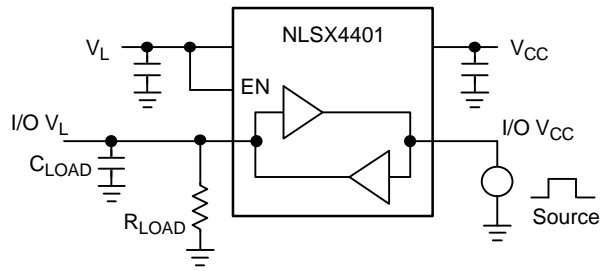

Figure 4. Rail-to-Rail Driving I/O  $V_{CC}$

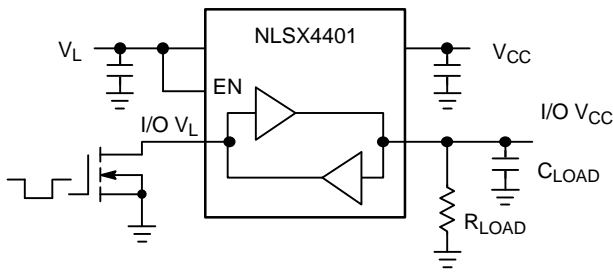

Figure 5. Open-Drain Driving I/O  $V_L$

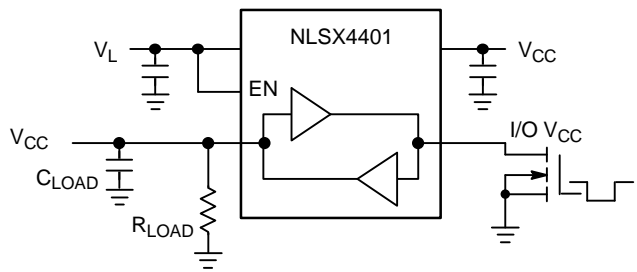

Figure 6. Open-Drain Driving I/O  $V_{CC}$

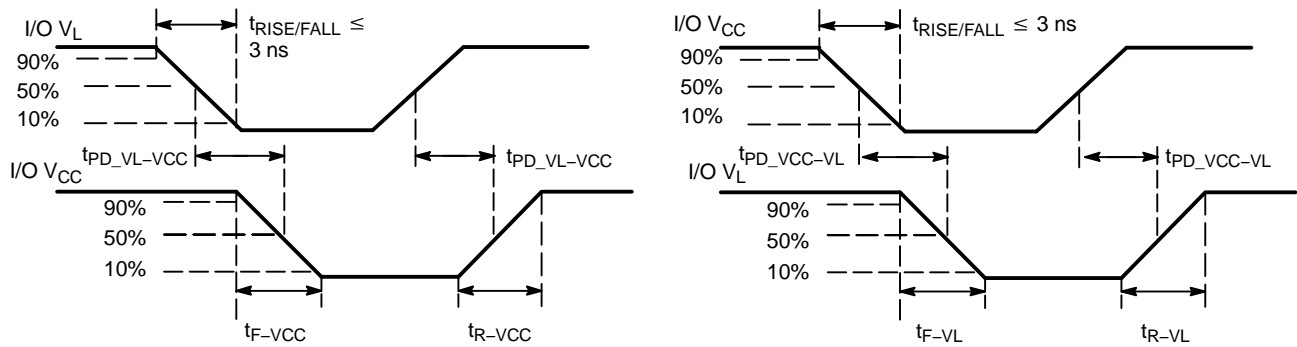
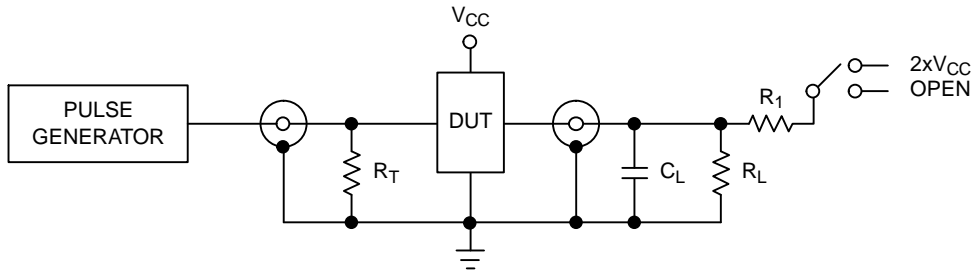

Figure 7. Definition of Timing Specification Parameters

# NLSX4401



Test	Switch
$t_{PZH}$ , $t_{PHZ}$	Open
$t_{PZL}$ , $t_{PLZ}$	$2 \times V_{CC}$

$C_L = 15 \text{ pF}$  or equivalent (Includes jig and probe capacitance)  
 $R_L = R_1 = 50 \text{ k}\Omega$  or equivalent  
 $R_T = Z_{OUT}$  of pulse generator (typically  $50 \Omega$ )

**Figure 8. Test Circuit for Enable/Disable Time Measurement**

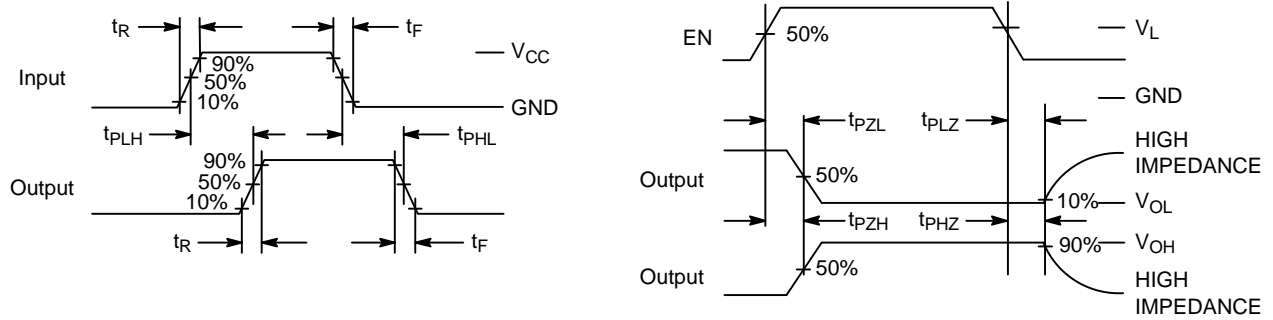

**Figure 9. Timing Definitions for Propagation Delays and Enable/Disable Measurement**

## APPLICATIONS INFORMATION

### Level Translator Architecture

The NLSX4401 auto sense translator provides bi-directional voltage level shifting to transfer data in multiple supply voltage systems. This device has two supply voltages,  $V_L$  and  $V_{CC}$ , which set the logic levels on the input and output sides of the translator. When used to transfer data from the I/O  $V_L$  to the I/O  $V_{CC}$  ports, input signals referenced to the  $V_L$  supply are translated to output signals with a logic level matched to  $V_{CC}$ . In a similar manner, the I/O  $V_{CC}$  to I/O  $V_L$  translation shifts input signals with a logic level compatible to  $V_{CC}$  to an output signal matched to  $V_L$ .

The NLSX4401 consists of two bi-directional channels that independently determine the direction of the data flow without requiring a directional pin. The one-shot circuits are used to detect the rising or falling input signals. In addition, the one shots decrease the rise and fall time of the output signal for high-to-low and low-to-high transitions.

Each input/output channel has an internal 10 k $\Omega$  pull-up. The magnitude of the pull-up resistors can be reduced by connecting external resistors in parallel to the internal 10 k $\Omega$  resistors.

### Input Driver Requirements

The rise ( $t_R$ ) and fall ( $t_F$ ) timing parameters of the open drain outputs depend on the magnitude of the pull-up resistors. In addition, the propagation times ( $t_{PHL}$  /  $t_{PLH}$ ), skew ( $t_{PSKEW}$ ) and maximum data rate depend on the

impedance of the device that is connected to the translator. The timing parameters listed in the data sheet assume that the output impedance of the drivers connected to the translator is less than 50 k $\Omega$ .

### Enable Input (EN)

The NLSX4401 has an Enable pin (EN) that provides tri-state operation at the I/O pins. Driving the Enable pin to a low logic level minimizes the power consumption of the device and drives the I/O  $V_{CC}$  and I/O  $V_L$  pins to a high impedance state. Normal translation operation occurs when the EN pin is equal to a logic high signal. The EN pin is referenced to the  $V_L$  supply and has Overvoltage Tolerant (OVT) protection.

### Power Supply Guidelines

During normal operation, supply voltage  $V_L$  can be greater than, less than or equal to  $V_{CC}$ . The sequencing of the power supplies will not damage the device during the power up operation.

For optimal performance, 0.01  $\mu$ F to 0.1  $\mu$ F decoupling capacitors should be used on the  $V_{CCA}$  and  $V_{CCB}$  power supply pins. Ceramic capacitors are a good design choice to filter and bypass any noise signals on the voltage lines to the ground plane of the PCB. The noise immunity will be maximized by placing the capacitors as close as possible to the supply and ground pins, along with minimizing the PCB connection traces.

# NLSX4401

## PACKAGE DIMENSIONS

UDFN6, 1.45x1, 0.5P  
CASE 517AQ  
ISSUE O

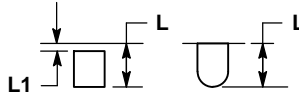
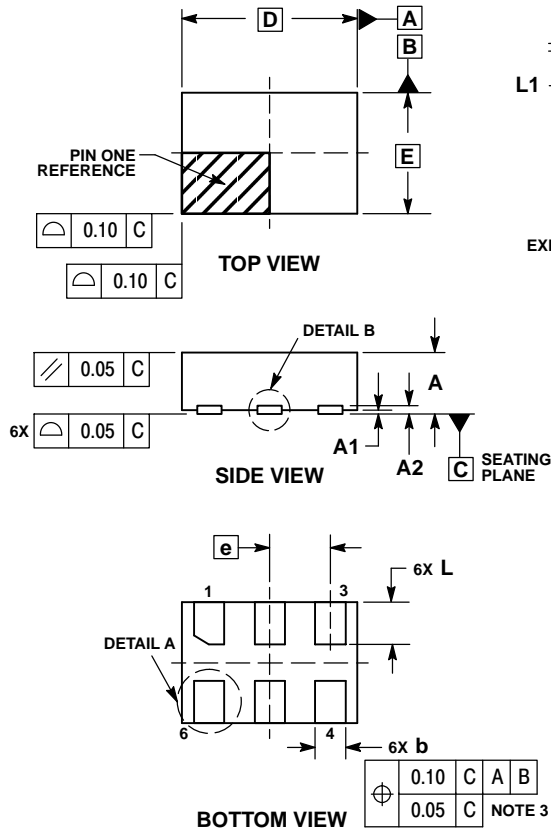

DETAIL A  
OPTIONAL  
CONSTRUCTIONS

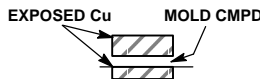

DETAIL B  
OPTIONAL  
CONSTRUCTIONS

NOTES:

1. DIMENSIONING AND TOLERANCING PER ASME Y14.5M, 1994.
2. CONTROLLING DIMENSION: MILLIMETERS.
3. DIMENSION b APPLIES TO PLATED TERMINAL AND IS MEASURED BETWEEN 0.15 AND 0.30 mm FROM THE TERMINAL TIP.

DIM	MILLIMETERS	
	MIN	MAX
A	0.45	0.55
A1	0.00	0.05
A2	0.07	REF
b	0.20	0.30
D	1.45	BSC
E	1.00	BSC
e	0.50	BSC
L	0.30	0.40
L1	---	0.15

### MOUNTING FOOTPRINT

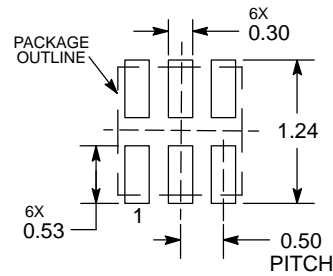

DIMENSIONS: MILLIMETERS

\*For additional information on our Pb-Free strategy and soldering details, please download the ON Semiconductor Soldering and Mounting Techniques Reference Manual, SOLDERRM/D.

ON Semiconductor and are trademarks of Semiconductor Components Industries, LLC dba ON Semiconductor or its subsidiaries in the United States and/or other countries. ON Semiconductor owns the rights to a number of patents, trademarks, copyrights, trade secrets, and other intellectual property. A listing of ON Semiconductor's product/patent coverage may be accessed at [www.onsemi.com/site/pdf/Patent-Marketing.pdf](http://www.onsemi.com/site/pdf/Patent-Marketing.pdf). ON Semiconductor reserves the right to make changes without further notice to any products herein. ON Semiconductor makes no warranty, representation or guarantee regarding the suitability of its products for any particular purpose, nor does ON Semiconductor assume any liability arising out of the application or use of any product or circuit, and specifically disclaims any and all liability, including without limitation special, consequential or incidental damages. Buyer is responsible for its products and applications using ON Semiconductor products, including compliance with all laws, regulations and safety requirements or standards, regardless of any support or applications information provided by ON Semiconductor. "Typical" parameters which may be provided in ON Semiconductor data sheets and/or specifications can and do vary in different applications and actual performance may vary over time. All operating parameters, including "Typicals" must be validated for each customer application by customer's technical experts. ON Semiconductor does not convey any license under its patent rights nor the rights of others. ON Semiconductor products are not designed, intended, or authorized for use as a critical component in life support systems or any FDA Class 3 medical devices or medical devices with a same or similar classification in a foreign jurisdiction or any devices intended for implantation in the human body. Should Buyer purchase or use ON Semiconductor products for any such unintended or unauthorized application, Buyer shall indemnify and hold ON Semiconductor and its officers, employees, subsidiaries, affiliates, and distributors harmless against all claims, costs, damages, and expenses, and reasonable attorney fees arising out of, directly or indirectly, any claim of personal injury or death associated with such unintended or unauthorized use, even if such claim alleges that ON Semiconductor was negligent regarding the design or manufacture of the part. ON Semiconductor is an Equal Opportunity/Affirmative Action Employer. This literature is subject to all applicable copyright laws and is not for resale in any manner.

### PUBLICATION ORDERING INFORMATION

**LITERATURE FULFILLMENT:**

Literature Distribution Center for ON Semiconductor  
19521 E. 32nd Pkwy, Aurora, Colorado 80011 USA  
Phone: 303-675-2175 or 800-344-3860 Toll Free USA/Canada  
Fax: 303-675-2176 or 800-344-3867 Toll Free USA/Canada  
Email: [orderlit@onsemi.com](mailto:orderlit@onsemi.com)

**N. American Technical Support:** 800-282-9855 Toll Free  
USA/Canada  
**Europe, Middle East and Africa Technical Support:**  
Phone: 421 33 790 2910

**ON Semiconductor Website:** [www.onsemi.com](http://www.onsemi.com)

**Order Literature:** <http://www.onsemi.com/orderlit>

For additional information, please contact your local Sales Representative