

Panasonic
ideas for life

**COMPACT POWER RELAY
FOR INDUCTIVE LOAD**

JM RELAYS

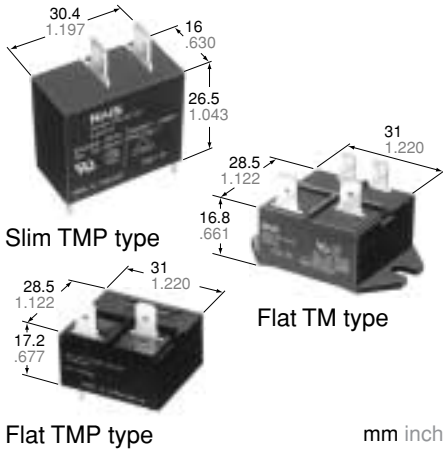

- **Excellent contact welding resistance**
High contact pressure, a forced opening mechanism, and a forced wiping mechanism realizes an excellent contact welding resistance.
- **High breakdown voltage and surge resistant relay**
More than 6.4 mm .252 inch maintained for the insulation distance between contacts and coil, and the breakdown voltage between contacts and coil is 5,000 V for 1 minute. In addition, the surge resistance between contacts and coil is greater than 10,000 V.
- **Resistant to external force**
An absorber mechanism is used on the load terminals, giving a large improvement in characteristics variations caused by the external force during FASTON placement/removal.

- **Flux resistance mechanism**
The terminal area is plugged with resin to prevent flux seepage during PCB mounting. (TMP type)
- **Conforms to the various safety standards**
UL, CSA approved.
TÜV, VDE under application.
- **The line up can support economical mounting methods.**
The relay are equipped with a drive terminal (coil terminal) on one side for PCBs, and a load terminal (tab terminal #250) on the reverse side. The line up includes the TM type which can be attached directly to the PCB composing a drive circuit, and the TMP type which supports economical wiring. The TMP type can also be directly attached, and a high capacity load can be wired to the tab terminal.

FEATURES

• **Compact, high-capacity, and resistant to inductive loads**
The relay is a compact 16×30.4×26.5 mm .630×1.197×1.043 inch. It can control an inductive load (cosφ = 0.7) with inrush current of 70 A and steady state current of 20 A.

SPECIFICATIONS

Contact			
Arrangement		1 Form A	
Initial contact resistance, max. (By voltage drop 6 V DC 1 A)		30 mΩ (Cd free type: 100 mΩ)	
Contact material		Silver alloy	
Rating (resistive load)	Nominal switching capacity		20 A 250 V AC
	Max. switching power		5,000 VA
	Max. switching voltage		250 V AC
	Max. switching current		20 A
	Min. switching capacity#1		100 mA, 5 V DC
Expected life (min. ope.)	Electrical Life (at 20 cpm)	Mechanical (at 180 cpm)	
		Resistive load 20 A, 250 V AC (cosφ = 1)	
	Inductive load	Inrush 70 A, Steady 20 A (250 V AC cosφ = 0.7)	
		Inrush 80 A, Cut-off 80 A (When the motor is locked) (250 V AC cosφ = 0.7)	

Coil	
Nominal operating power	900 mW

#1 This value can change due to the switching frequency, environmental conditions, and desired reliability level, therefore it is recommended to check this with the actual load.

- Remarks**
- * Specifications will vary with foreign standards certification ratings.
 - *1 Measurement at same location as "Initial breakdown voltage" section
 - *2 Detection current: 10mA
 - *3 Wave is standard shock voltage of ±1.2 × 50μs according to JEC-212-1981
 - *4 Excluding contact bounce time
 - *5 Half-wave pulse of sine wave: 11ms; detection time: 10μs
 - *6 Half-wave pulse of sine wave: 6ms
 - *7 Detection time: 10μs
 - *8 Refer to 6. Conditions for operation, transport and storage mentioned in AMBIENT ENVIRONMENT

Characteristics		
Max. operating speed		180 cpm
Initial insulation resistance*1		Min. 100 MΩ (at 500 V DC)
Initial breakdown voltage*2	Between open contacts	1,000 Vrms for 1 min.
	Between contacts and coil	5,000 Vrms for 1 min.
Surge voltage between contact and coil*3		Min. 10,000 V
Operate time*4 (at nominal voltage)(at 20°C)		Max. 20ms (Approx. 8 ms)
Release time (without diode)*4 (at nominal voltage)(at 20°C)		Max. 10ms (Approx. 3 ms)
Temperature rise (at 60°C)		Max. 55°C (Contact switching current: 20 A/voltage applied to coil: 100%V)
Shock resistance	Functional*5	Min. 98 m/s ² {10 G}
	Destructive*6	Min. 980 m/s ² {100 G}
Vibration resistance	Functional*7	10 to 55 Hz at double amplitude of 1.6 mm
	Destructive	10 to 55 Hz at double amplitude of 2 mm
Conditions for operation, transport and storage*8 (Not freezing and condensing at low temperature)	Ambient temp.	-40°C to +60°C -40°F to +140°F
	Humidity	5 to 85% R.H.
Unit weight	Slim TMP	Approx. 28 g .99 oz
	Flat TMP	Approx. 32 g 1.13 oz
	Flat TM	Approx. 33 g 1.16 oz

TYPICAL APPLICATIONS ORDERING INFORMATION

- Compressor and heater control in air conditioners
- Power control in hot air type heaters
- Magnetron control in microwave ovens
- Lamp and motor control in OA equipment such as copiers and facsimiles.

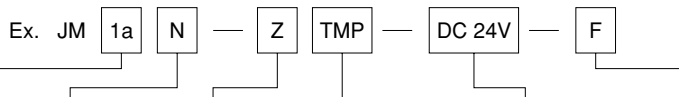

Contact arrangement	Pickup voltage	Classification of type	Mounting classification	Coil voltage	Environmental support
1a: 1 Form A	N: 70% of nominal voltage	Nil: Slim type Z: Flat type	TMP: TMP type TM: TM type (Flat type) P: PCB type(Slim type)	DC 5, 6, 9, 12, 24, 48 V	F: RoHS Directive conforming type (AgSnO ₂ type) Nil: RoHS Directive non-conforming type (AgCdO type)

(Note) 1. Standard packing: Carton: 50pcs. Case: 200pcs.
UL/CSA, VDE approved type is standard.

TYPES AND COIL DATA (at 20°C 68°F)

Part No.				Nominal voltage, V DC	Pick-up voltage	Drop-out voltage,	Nominal operating current, mA	Coil resistance, Ω (±10%)	Nominal operating power, mW	Max. allowable voltage, V DC
Slim		Flat								
TMP	PCB	TMP	TM							
JM1aN-TMP-DC5V (-F)	JM1aN-P-DC5V (-F)	JM1aN-ZTMP-DC5V (-F)	JM1aN-ZTM-DC5V (-F)	5	3.5	0.5	180	27.8	900	5.5
JM1aN-TMP-DC6V (-F)	JM1aN-P-DC6V (-F)	JM1aN-ZTMP-DC6V (-F)	JM1aN-ZTM-DC6V (-F)	6	4.2	0.6	150	40	900	6.6
JM1aN-TMP-DC9V (-F)	JM1aN-P-DC9V (-F)	JM1aN-ZTMP-DC9V (-F)	JM1aN-ZTM-DC9V (-F)	9	6.3	0.9	100	90	900	9.9
JM1aN-TMP-DC12V (-F)	JM1aN-P-DC12V (-F)	JM1aN-ZTMP-DC12V (-F)	JM1aN-ZTM-DC12V (-F)	12	8.4	1.2	75	160	900	13.2
JM1aN-TMP-DC24V (-F)	JM1aN-P-DC24V (-F)	JM1aN-ZTMP-DC24V (-F)	JM1aN-ZTM-DC24V (-F)	24	16.8	2.4	37.5	640	900	26.4
JM1aN-TMP-DC48V (-F)	JM1aN-P-DC48V (-F)	JM1aN-ZTMP-DC48V (-F)	JM1aN-ZTM-DC48V (-F)	48	33.6	4.8	18.75	2,560	900	52.8

DIMENSIONS

mm inch

Slim TMP type

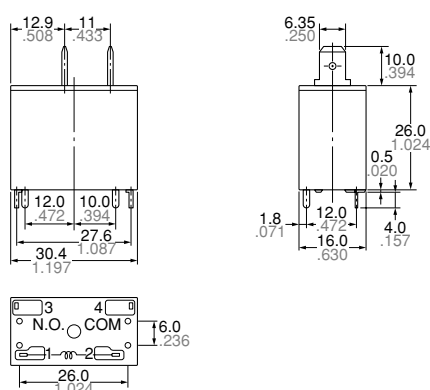

General tolerance: ±0.4 ±.016

Schematic

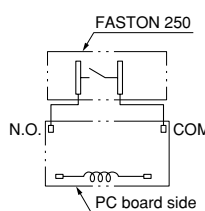

PC board pattern

(Copper-side view)

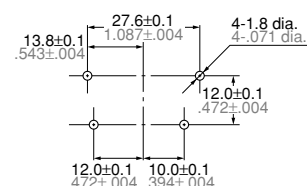

Slim PCB type

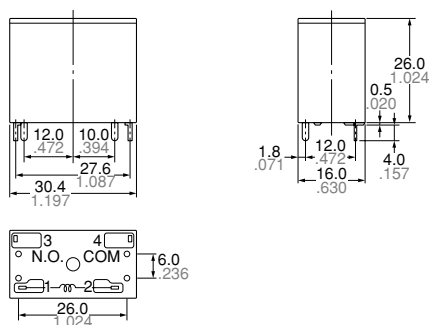

General tolerance: ±0.4 ±.016

Schematic

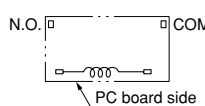

PC board pattern

(Copper-side view)

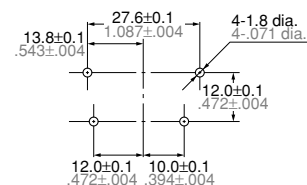

Tolerance: ±0.1 ±.004

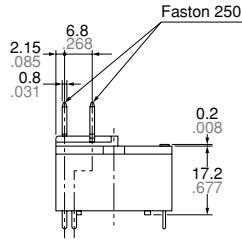
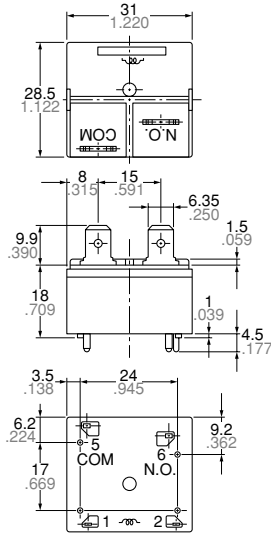

Schematic

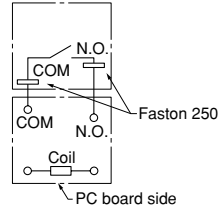

PC board pattern (Bottom view)

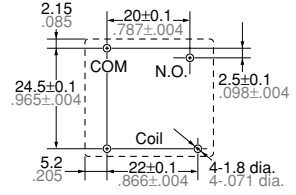

General tolerance: $\pm 0.4 \pm 0.16$

Tolerance: $\pm 0.1 \pm 0.04$

Flat TM type

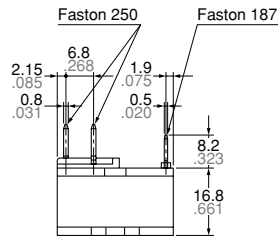
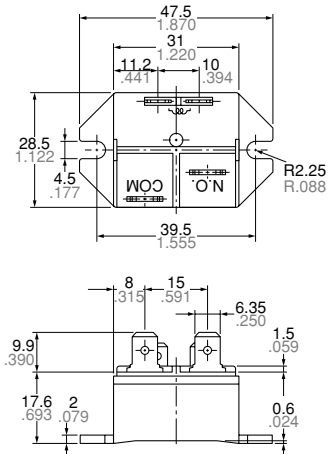

Schematic

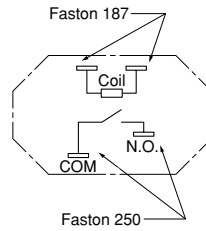

Panel cutout

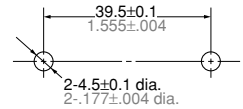

General tolerance: $\pm 0.4 \pm 0.16$

REFERENCE DATA

1. Coil temperature rise

Place to be measured: Inside of coil
Ambient temperature: 25°C 77°F

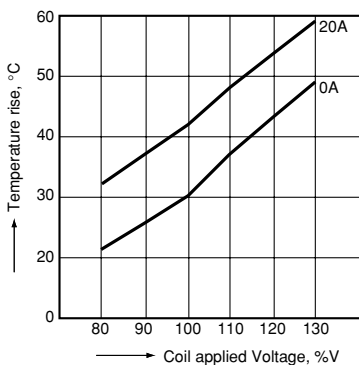

2. Ambient temperature characteristics

Sample: JM1aN-TMP-DC24V, 5 pcs.

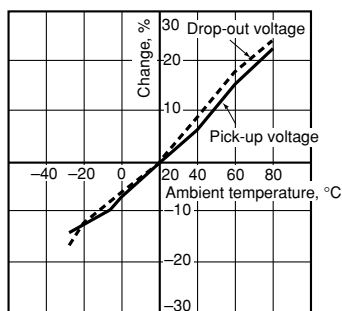

3. Operate/release time

Sample: JM1aN-TMP-DC24V, 5 pcs.

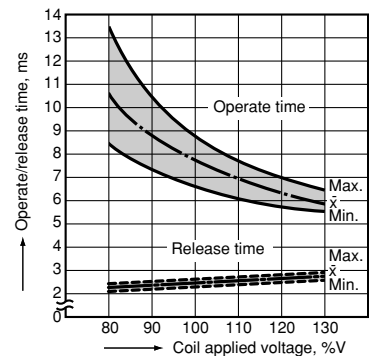

4. Life curve

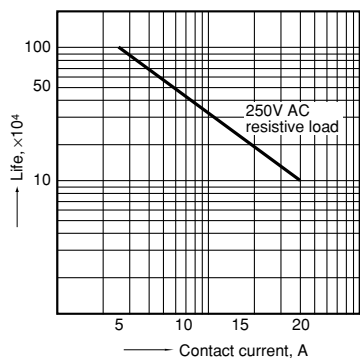

5-(1). 200 V AC electrical life test (200 V AC inverter dummy load)

Sample: JM1aN-TMP-DC12V, 6 pcs.
 Load: Inrush 108 A, Steady 15 A,
 Inverter dummy 200 V AC
 Switching frequency: ON 5 s, OFF 5 s
 Circuit

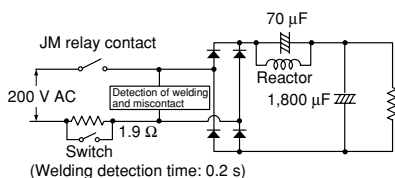

Change of pick-up and drop-out voltage

Contact welding: 0 time
 Miscontact: 0 time

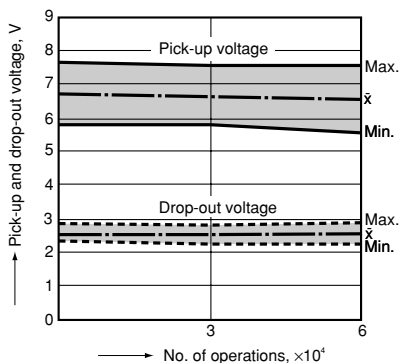

5-(2). 100 V AC electrical life test (100 V AC inverter dummy load)

Sample: JM1aN-TMP-DC12V, 20 pcs.
 Load: Inrush 224 A, Steady 20A,
 Inverter dummy 100 V AC
 Switching frequency: ON 10 s, OFF 10 s
 Circuit

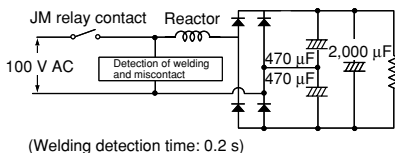

Change of pick-up and drop-out voltage

Contact welding: 0 time
 Miscontact: 0 time

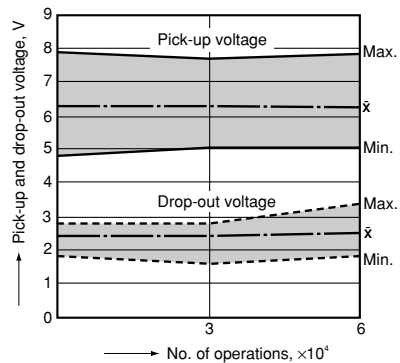

5-(3). Inrush 70 A, Steady 20 A, 250 V AC compressor dummy load

Sample: JM1aN-TMP-DC12V, 6 pcs.
 Load: (Endurance) inrush 70 A cosφ = 0.7 (0.3 s),
 steady 20A pf = 0.9,
 250V AC compressor dummy
 (Overload) 80A cosφ = 0.7, 250 V AC
 No. of operations: (Endurance) 10⁵ times
 (Overload) 1,000 times (after
 endurance test)
 Switching frequency: (Endurance) ON 1.5 s,
 OFF 1.5 s
 (Overload) ON 3 s,
 OFF 2 min., 57 s

Circuit (endurance)

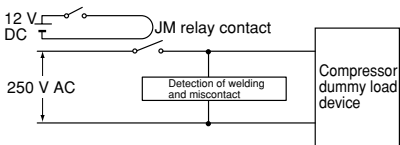

Change of pick-up and drop-out voltage

Contact welding: 0 time
 Miscontact: 0 time

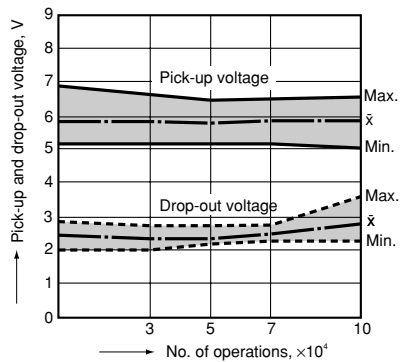

For Cautions for Use, see Relay Technical Information