

CM1431

LCD and Camera EMI Filter Array with ESD Protection

Product Description

The CM1431 is a family of pi-style EMI filter arrays with ESD protection, which integrates four, six and eight filters (C-R-C) in small form factor WDFN 0.40 mm pitch packages. The CM1431 has component values of 15 pF – 100 Ω – 15 pF per channel. The CM1431 has a cut-off frequency of 120 MHz and can be used in applications with data rates up to 48 Mbps. The parts include ESD diodes on every pin, which provide a very high level of protection for sensitive electronic components that may be subjected to electrostatic discharge (ESD). The ESD protection diodes safely dissipate ESD strikes of ±15 kV, well beyond the maximum requirement of the IEC61000-4-2 international standard. Using the MIL-STD-883 (Method 3015) specification for Human Body Model (HBM) ESD, the pins are protected for contact discharges at greater than ±30 kV.

These devices are particularly well-suited for portable electronics (e.g. wireless handsets, PDAs, notebook computers) because of their small package and easy-to-use pin assignments. In particular, the CM1431 is ideal for EMI filtering and protecting data and control lines for the I/O data ports, LCD display and camera interface in mobile handsets.

The CM1431 is housed in space-saving, low-profile 8-, 12- and 16-lead WDFN packages with a 0.40 mm pitch and is available with lead-free finishing. This smaller size WDFN package provides up to 42% board space saving vs. the 0.50 mm pitch WDFN packages.

Features

- Four, Six and Eight Channels of EMI Filtering with Integrated ESD Protection
- Pi-Style EMI Filters in a Capacitor-Resistor-Capacitor (C-R-C) Network
- ±15 kV ESD Protection on Each Channel (IEC 61000-4-2 Level 4, Contact Discharge)
- ±30 kV ESD Protection on Each Channel (HBM)
- Greater than 35 dB Attenuation (Typical) at 1 GHz
- WDFN Package with 0.40 mm Lead Pitch:
 - ◆ 4-ch. = 8-lead WDFN
 - ◆ 6-ch. = 12-lead WDFN
 - ◆ 8-ch. = 16-lead WDFN
- Tiny WDFN Package Size:
 - ◆ 8-lead: 1.7 mm X 1.35 mm
 - ◆ 12-lead: 2.5 mm X 1.35 mm
 - ◆ 16-lead: 3.3 mm X 1.35 mm
- Increased Robustness against Vertical Impacts During Manufacturing Process
- These Devices are Pb-Free and are RoHS Compliant

Applications

- LCD and Camera Data Lines in Mobile Handsets
- I/O Port Protection for Mobile Handsets, Notebook Computers, PDAs, etc.
- EMI Filtering for Data Ports in Cell Phones, PDAs or Notebook Computers

- Wireless Handsets
- Handheld PCs/PDAs
- LCD and Camera Modules



ON Semiconductor®

<http://onsemi.com>



WDFN8
DF/DE SUFFIX
CASE 511BF



WDFN12
DF/DE SUFFIX
CASE 511BC

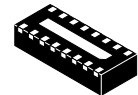

WDFN16
DF/DE SUFFIX
CASE 511AW

BLOCK DIAGRAM

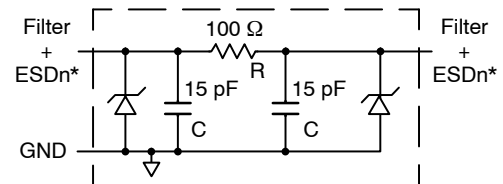

1 of 4, 6 or 8 EMI/RFI + ESD Channels

* See Package/Pinout Diagrams for expanded pin information.

MARKING DIAGRAM

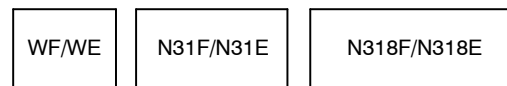

WF/WE = CM1431-04DF/CM1431-04DE
 N31F/N31E = CM1431-06DF/CM1431-06DE
 N318F/N318E = CM1431-08DF/CM1431-08DE

ORDERING INFORMATION

Device	Package	Shipping†
CM1431-04DF	WDFN-8 (Pb-Free)	3000/Tape & Reel
CM1431-04DE	WDFN-8 (Pb-Free)	3000/Tape & Reel
CM1431-06DF	WDFN-12 (Pb-Free)	3000/Tape & Reel
CM1431-06DE	WDFN-12 (Pb-Free)	3000/Tape & Reel
CM1431-08DF	WDFN-16 (Pb-Free)	3000/Tape & Reel
CM1431-08DE	WDFN-16 (Pb-Free)	3000/Tape & Reel

†For information on tape and reel specifications, including part orientation and tape sizes, please refer to our Tape and Reel Packaging Specification Brochure, BRD8011/D.

CM1431

PACKAGE / PINOUT DIAGRAMS

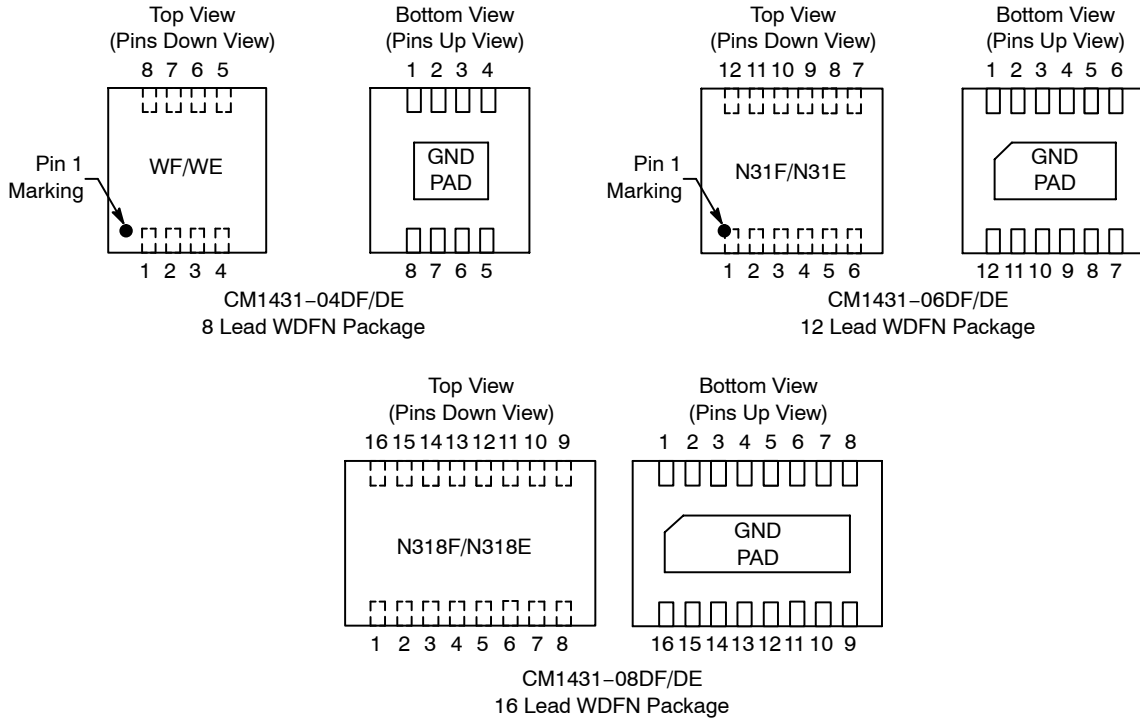

Table 1. PIN DESCRIPTIONS

Device Pin(s)			Name	Description	Device Pin(s)			Name	Description
-04	-06	-08			-04	-06	-08		
1	1	1	FILTER1	Filter + ESD Channel 1	8	12	16	FILTER1	Filter + ESD Channel 1
2	2	2	FILTER2	Filter + ESD Channel 2	7	11	15	FILTER2	Filter + ESD Channel 2
3	3	3	FILTER3	Filter + ESD Channel 3	6	10	14	FILTER3	Filter + ESD Channel 3
4	4	4	FILTER4	Filter + ESD Channel 4	5	9	13	FILTER4	Filter + ESD Channel 4
-	5	5	FILTER5	Filter + ESD Channel 5	-	8	12	FILTER5	Filter + ESD Channel 5
-	6	6	FILTER6	Filter + ESD Channel 6	-	7	11	FILTER6	Filter + ESD Channel 6
-	-	7	FILTER7	Filter + ESD Channel 7	-	-	10	FILTER7	Filter + ESD Channel 7
-	-	8	FILTER8	Filter + ESD Channel 8	-	-	9	FILTER8	Filter + ESD Channel 8
GND PAD			GND	Device Ground	-	-	-	-	

CM1431

SPECIFICATIONS

Table 2. ABSOLUTE MAXIMUM RATINGS

Parameter	Rating	Units
Storage Temperature Range	-65 to +150	°C
DC Power per Resistor	100	mW
DC Package Power Rating	500	mW

Stresses exceeding Maximum Ratings may damage the device. Maximum Ratings are stress ratings only. Functional operation above the Recommended Operating Conditions is not implied. Extended exposure to stresses above the Recommended Operating Conditions may affect device reliability.

Table 3. STANDARD OPERATING CONDITIONS

Parameter	Rating	Units
Operating Temperature Range	-40 to +85	°C

Table 4. ELECTRICAL OPERATING CHARACTERISTICS (Note 1)

Symbol	Parameter	Conditions	Min	Typ	Max	Units
R	Resistance		80	100	120	Ω
C _{TOTAL}	Total Channel Capacitance	At 2.5 V DC Reverse Bias, 1 MHz, 30 mV AC	24	30	36	pF
C	Capacitance C	At 2.5 V DC Reverse Bias, 1 MHz, 30 mV AC	12	15	18	pF
V _{DIODE}	Stand-off Voltage	I _{DIODE} = 10 μA		6.0		V
I _{LEAK}	Diode Leakage Current (Reverse Bias)	V _{DIODE} = 3.3 V		0.1	1.0	μA
V _{SIG}	Signal Clamp Voltage Positive Clamp Negative Clamp	I _{LOAD} = 10 mA I _{LOAD} = -10 mA	5.6 -1.5	6.8 -0.8	9.0 -0.4	V
V _{ESD}	In-system ESD Withstand Voltage a) Human Body Model, MIL-STD-883, Method 3015 b) Contact Discharge per IEC 61000-4-2 Level 4	(Note 2)	±30 ±15			kV
R _{DYN}	Dynamic Resistance Positive Negative			2.3 0.9		Ω
f _C	Cut-off Frequency Z _{SOURCE} = 50 Ω, Z _{LOAD} = 50 Ω	R = 100 Ω, C = 15 pF		110		MHz
A _{1GHz}	Absolute Attenuation @ 1 GHz from 0 dB Level	Z _{SOURCE} = 50 Ω, Z _{LOAD} = 50 Ω, DC Bias = 0 V (Notes 1 and 3)		35		dB
A _{800MHz to 6GHz}	Absolute Attenuation @ 800 MHz to 6 GHz from 0 dB Level	Z _{SOURCE} = 50 Ω, Z _{LOAD} = 50 Ω, DC Bias = 0 V (Notes 1 and 3)		30		dB

1. T_A = 25°C unless otherwise specified.
2. ESD applied to input and output pins with respect to GND, one at a time.
3. Attenuation / RF curves characterized by a network analyzer using microprobes.

CM1431

PERFORMANCE INFORMATION

Typical Filter Performance ($T_A = 25^\circ\text{C}$, DC Bias = 0 V, 50 Ω Environment)

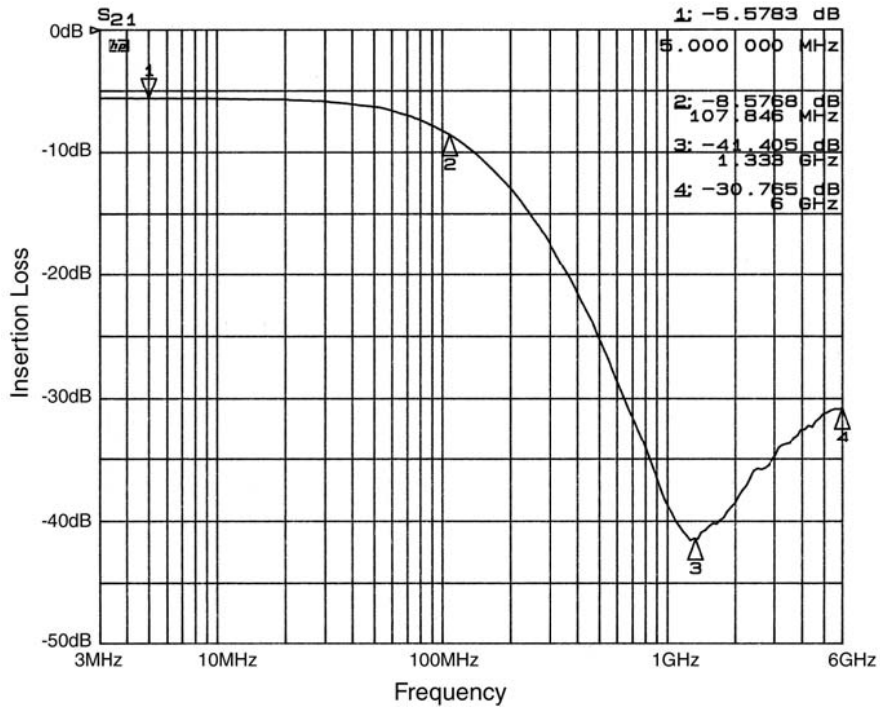

Figure 1. Insertion Loss vs. Frequency (FILTER1 Input to GND)

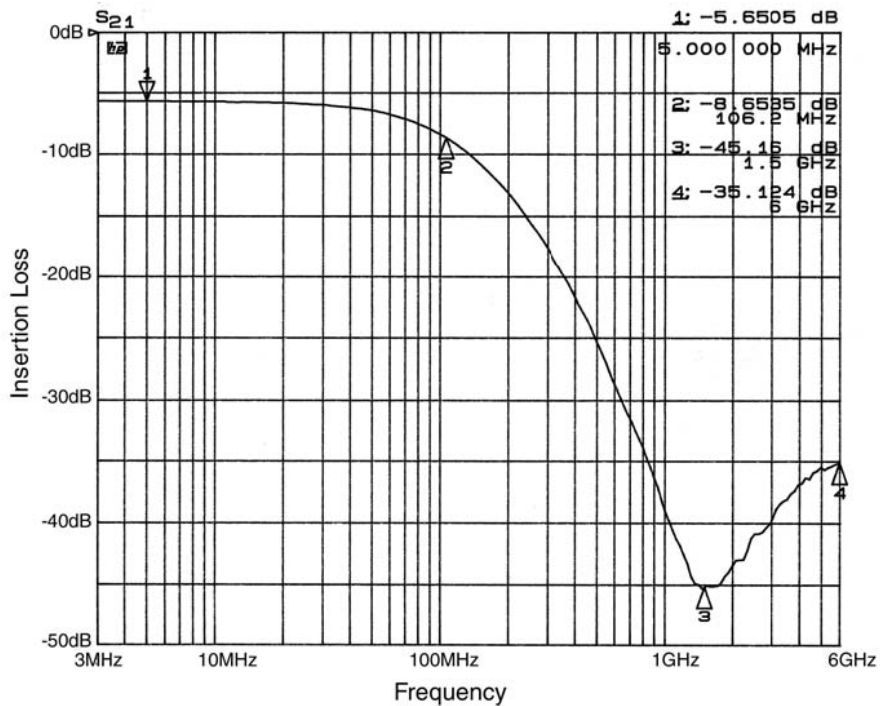

Figure 2. Insertion Loss vs. Frequency (FILTER2 Input to GND)

CM1431

PERFORMANCE INFORMATION (Cont'd)

Typical Filter Performance ($T_A = 25^\circ\text{C}$, DC Bias = 0 V, 50 Ω Environment)

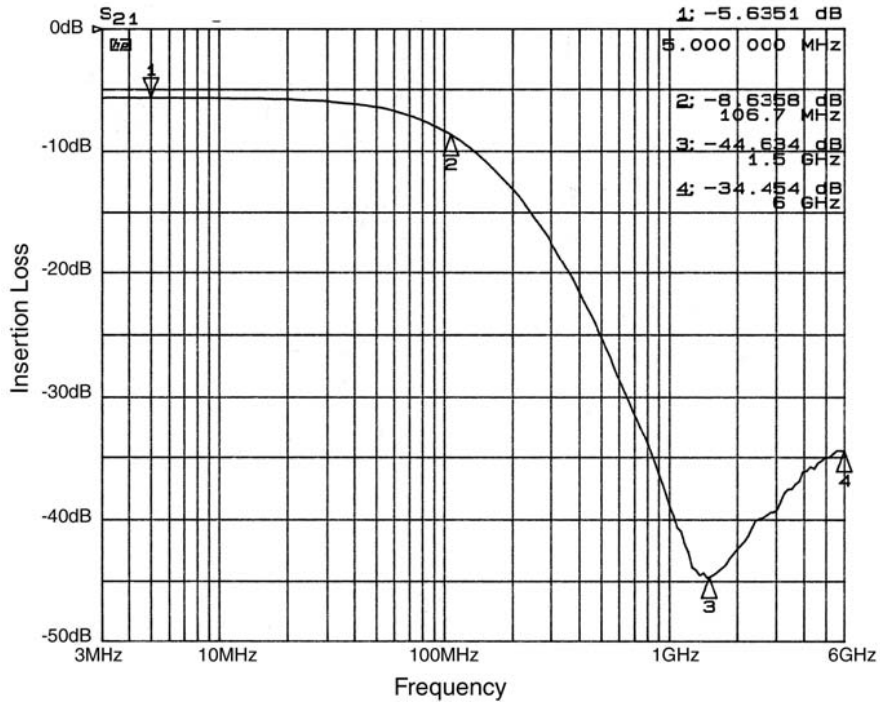

Figure 3. Insertion Loss vs. Frequency (FILTER3 Input to GND)

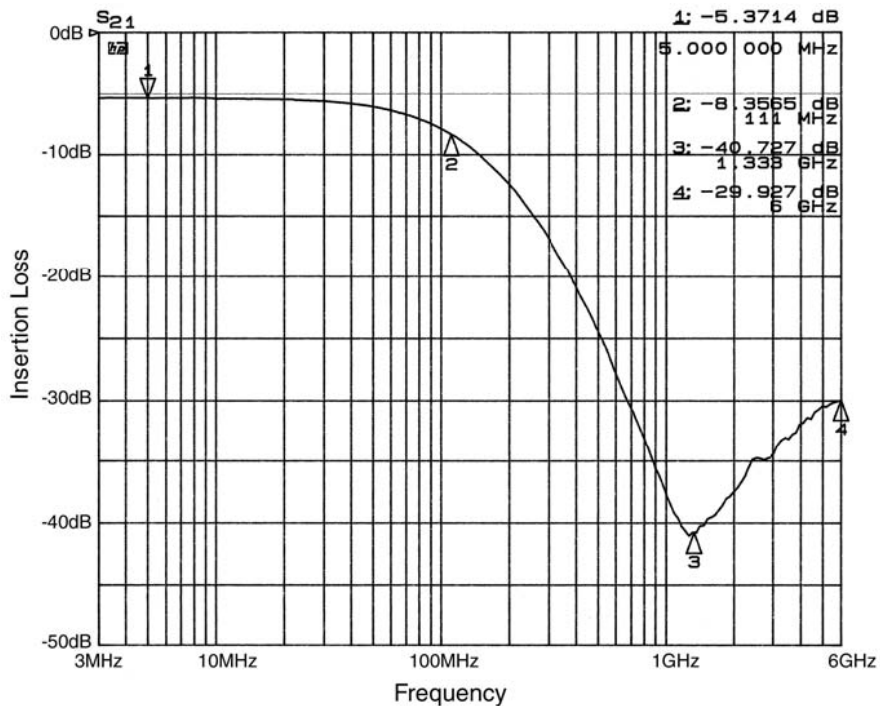

Figure 4. Insertion Loss vs. Frequency (FILTER4 Input to GND)

PERFORMANCE INFORMATION (Cont'd)

Typical Diode Capacitance vs. Input Voltage

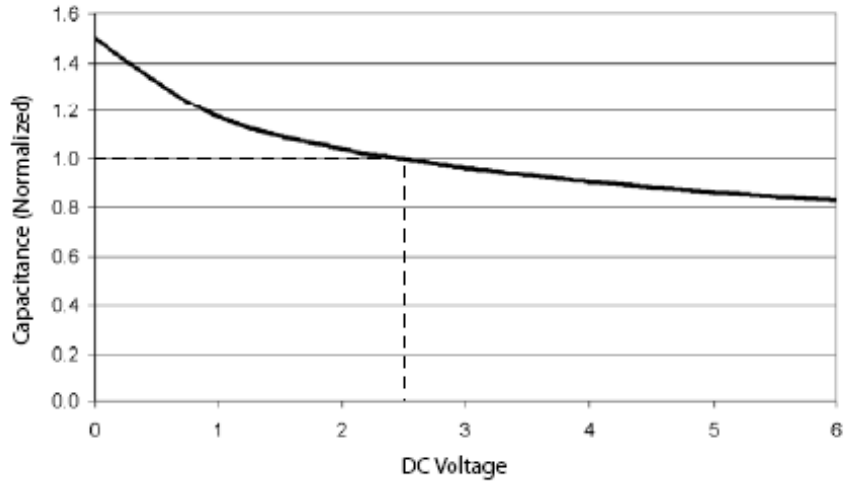
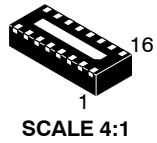

Figure 5. Filter Capacitance vs. Input Voltage
(normalized to capacitance at 2.5 V DC and 25°C)

MECHANICAL CASE OUTLINE

PACKAGE DIMENSIONS

ON Semiconductor®



WDFN16, 3.3x1.35, 0.4P
CASE 511AW-01
ISSUE O

DATE 06 JUL 2010

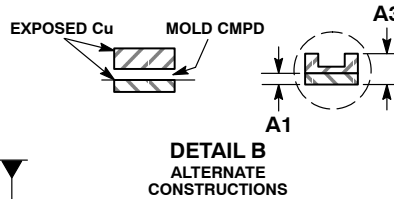
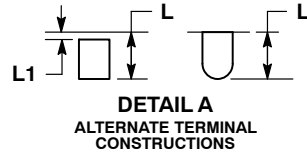
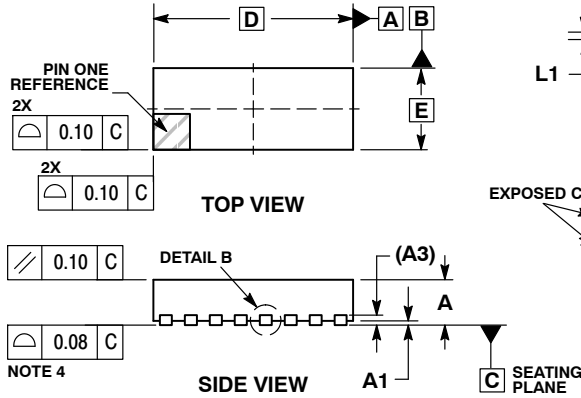

NOTES:

1. DIMENSIONING AND TOLERANCING PER ASME Y14.5M, 1994.
2. CONTROLLING DIMENSION: MILLIMETERS.
3. DIMENSION b APPLIES TO PLATED TERMINAL AND IS MEASURED BETWEEN 0.15 AND 0.30 MM FROM TERMINAL TIP.
4. COPLANARITY APPLIES TO THE EXPOSED PAD AS WELL AS THE TERMINALS.

MILLIMETERS		
DIM	MIN	MAX
A	0.70	0.80
A1	0.00	0.05
A3	0.20	REF
b	0.15	0.25
D	3.30	BSC
D2	2.70	2.90
E	1.35	BSC
E2	0.30	0.50
e	0.40	BSC
K	0.22	REF
L	0.15	0.35
L1	---	0.15

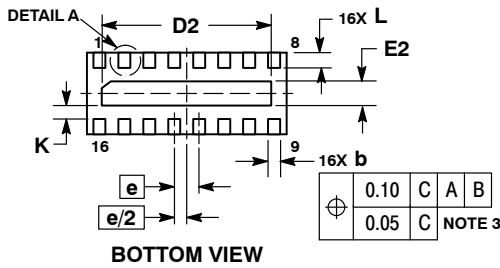

RECOMMENDED SOLDERING FOOTPRINT*

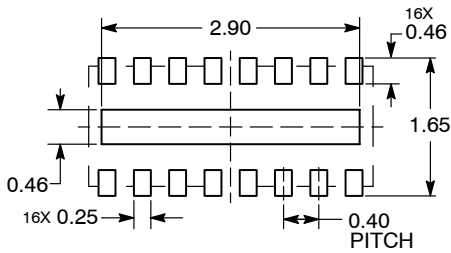

DIMENSION: MILLIMETERS

*For additional information on our Pb-Free strategy and soldering details, please download the ON Semiconductor Soldering and Mounting Techniques Reference Manual, SOLDERRM/D.

DOCUMENT NUMBER:	98AON48926E	Electronic versions are uncontrolled except when accessed directly from the Document Repository. Printed versions are uncontrolled except when stamped "CONTROLLED COPY" in red.
DESCRIPTION:	WDFN16, 3.3X1.35, 0.4P	PAGE 1 OF 1

ON Semiconductor and are trademarks of Semiconductor Components Industries, LLC dba ON Semiconductor or its subsidiaries in the United States and/or other countries. ON Semiconductor reserves the right to make changes without further notice to any products herein. ON Semiconductor makes no warranty, representation or guarantee regarding the suitability of its products for any particular purpose, nor does ON Semiconductor assume any liability arising out of the application or use of any product or circuit, and specifically disclaims any and all liability, including without limitation special, consequential or incidental damages. ON Semiconductor does not convey any license under its patent rights nor the rights of others.

MECHANICAL CASE OUTLINE

PACKAGE DIMENSIONS

ON Semiconductor®

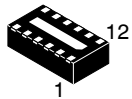

SCALE 4:1

WDFN12, 2.5x1.35, 0.4P
CASE 511BC-01
ISSUE O

DATE 06 JUL 2010

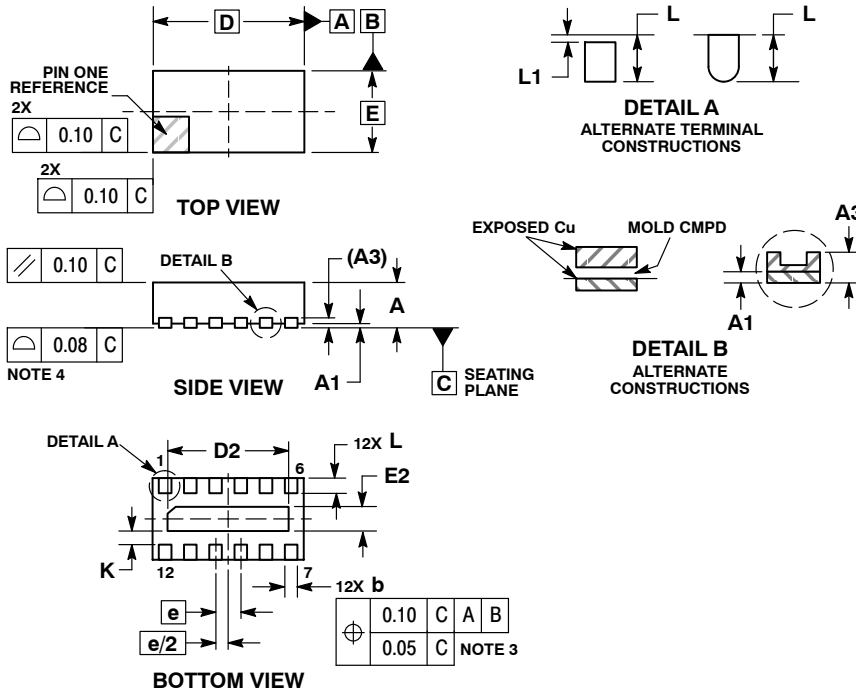

NOTES:

1. DIMENSIONING AND TOLERANCING PER ASME Y14.5M, 1994.
2. CONTROLLING DIMENSION: MILLIMETERS.
3. DIMENSION b APPLIES TO PLATED TERMINAL AND IS MEASURED BETWEEN 0.15 AND 0.30 MM FROM TERMINAL TIP.
4. COPLANARITY APPLIES TO THE EXPOSED PAD AS WELL AS THE TERMINALS.

RECOMMENDED SOLDERING FOOTPRINT*

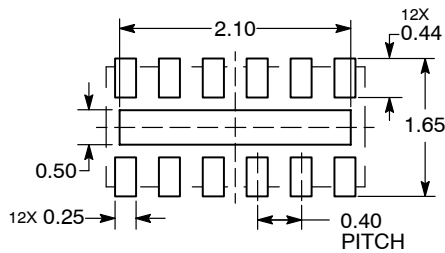

*For additional information on our Pb-Free strategy and soldering details, please download the ON Semiconductor Soldering and Mounting Techniques Reference Manual, SOLDERRM/D.

DOCUMENT NUMBER:	98AON48932E	Electronic versions are uncontrolled except when accessed directly from the Document Repository. Printed versions are uncontrolled except when stamped "CONTROLLED COPY" in red.
DESCRIPTION:	WDFN12, 2.5X1.35, 0.4P	PAGE 1 OF 1

ON Semiconductor and are trademarks of Semiconductor Components Industries, LLC dba ON Semiconductor or its subsidiaries in the United States and/or other countries. ON Semiconductor reserves the right to make changes without further notice to any products herein. ON Semiconductor makes no warranty, representation or guarantee regarding the suitability of its products for any particular purpose, nor does ON Semiconductor assume any liability arising out of the application or use of any product or circuit, and specifically disclaims any and all liability, including without limitation special, consequential or incidental damages. ON Semiconductor does not convey any license under its patent rights nor the rights of others.

MECHANICAL CASE OUTLINE

PACKAGE DIMENSIONS

ON Semiconductor®

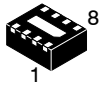

SCALE 4:1

WDFN8, 1.7x1.35, 0.4P
CASE 511BF-01
ISSUE O

DATE 21 JUL 2010

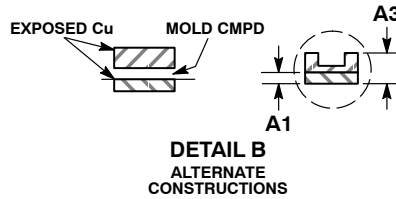
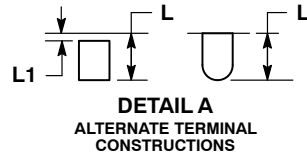
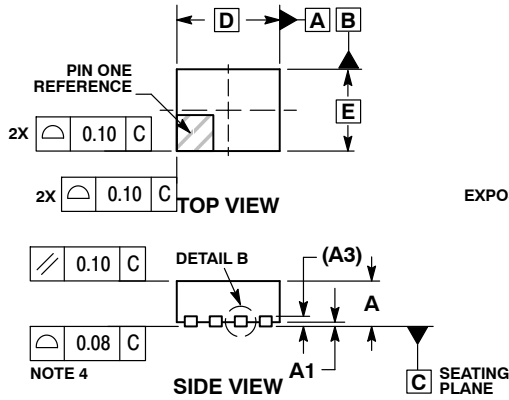

- NOTES:
1. DIMENSIONING AND TOLERANCING PER ASME Y14.5M, 1994.
 2. CONTROLLING DIMENSION: MILLIMETERS.
 3. DIMENSION b APPLIES TO PLATED TERMINAL AND IS MEASURED BETWEEN 0.15 AND 0.30 MM FROM TERMINAL TIP.
 4. COPLANARITY APPLIES TO THE EXPOSED PAD AS WELL AS THE TERMINALS.

DIM	MILLIMETERS	
	MIN	MAX
A	0.70	0.80
A1	0.00	0.05
A3	0.20	REF
b	0.15	0.25
D	1.7	BSC
E	1.10	1.30
E2	0.30	0.50
e	0.40	BSC
K	0.22	REF
L	0.15	0.35
L1	---	0.15

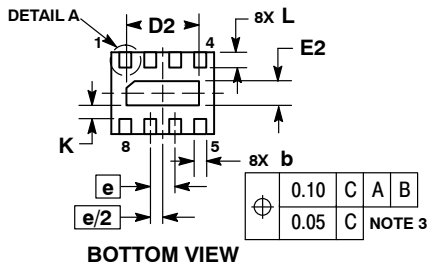

RECOMMENDED SOLDERING FOOTPRINT*

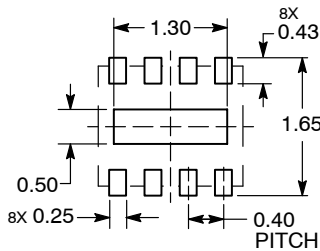

DIMENSION: MILLIMETERS

*For additional information on our Pb-Free strategy and soldering details, please download the ON Semiconductor Soldering and Mounting Techniques Reference Manual, SOLDERRM/D.

DOCUMENT NUMBER:	98AON48937E	Electronic versions are uncontrolled except when accessed directly from the Document Repository. Printed versions are uncontrolled except when stamped "CONTROLLED COPY" in red.
DESCRIPTION:	WDFN8, 1.7X1.35, 0.4P	PAGE 1 OF 1

ON Semiconductor and are trademarks of Semiconductor Components Industries, LLC dba ON Semiconductor or its subsidiaries in the United States and/or other countries. ON Semiconductor reserves the right to make changes without further notice to any products herein. ON Semiconductor makes no warranty, representation or guarantee regarding the suitability of its products for any particular purpose, nor does ON Semiconductor assume any liability arising out of the application or use of any product or circuit, and specifically disclaims any and all liability, including without limitation special, consequential or incidental damages. ON Semiconductor does not convey any license under its patent rights nor the rights of others.

onsemi, **Onsemi**, and other names, marks, and brands are registered and/or common law trademarks of Semiconductor Components Industries, LLC dba "**onsemi**" or its affiliates and/or subsidiaries in the United States and/or other countries. **onsemi** owns the rights to a number of patents, trademarks, copyrights, trade secrets, and other intellectual property. A listing of **onsemi**'s product/patent coverage may be accessed at www.onsemi.com/site/pdf/Patent-Marking.pdf. **onsemi** reserves the right to make changes at any time to any products or information herein, without notice. The information herein is provided "as-is" and **onsemi** makes no warranty, representation or guarantee regarding the accuracy of the information, product features, availability, functionality, or suitability of its products for any particular purpose, nor does **onsemi** assume any liability arising out of the application or use of any product or circuit, and specifically disclaims any and all liability, including without limitation special, consequential or incidental damages. Buyer is responsible for its products and applications using **onsemi** products, including compliance with all laws, regulations and safety requirements or standards, regardless of any support or applications information provided by **onsemi**. "Typical" parameters which may be provided in **onsemi** data sheets and/or specifications can and do vary in different applications and actual performance may vary over time. All operating parameters, including "Typicals" must be validated for each customer application by customer's technical experts. **onsemi** does not convey any license under any of its intellectual property rights nor the rights of others. **onsemi** products are not designed, intended, or authorized for use as a critical component in life support systems or any FDA Class 3 medical devices or medical devices with a same or similar classification in a foreign jurisdiction or any devices intended for implantation in the human body. Should Buyer purchase or use **onsemi** products for any such unintended or unauthorized application, Buyer shall indemnify and hold **onsemi** and its officers, employees, subsidiaries, affiliates, and distributors harmless against all claims, costs, damages, and expenses, and reasonable attorney fees arising out of, directly or indirectly, any claim of personal injury or death associated with such unintended or unauthorized use, even if such claim alleges that **onsemi** was negligent regarding the design or manufacture of the part. **onsemi** is an Equal Opportunity/Affirmative Action Employer. This literature is subject to all applicable copyright laws and is not for resale in any manner.

PUBLICATION ORDERING INFORMATION

LITERATURE FULFILLMENT:

Email Requests to: orderlit@onsemi.com

onsemi Website: www.onsemi.com

TECHNICAL SUPPORT

North American Technical Support:

Voice Mail: 1 800-282-9855 Toll Free USA/Canada

Phone: 011 421 33 790 2910

Europe, Middle East and Africa Technical Support:

Phone: 00421 33 790 2910

For additional information, please contact your local Sales Representative