

## MAX15070A/MAX15070B

## 7A Sink, 3A Source, 12ns, SOT23 MOSFET Drivers

### General Description

The MAX15070A/MAX15070B are high-speed MOSFET drivers capable of sinking 7A and sourcing 3A peak currents. The ICs, which are an enhancement over MAX5048 devices, have inverting and noninverting inputs that provide greater flexibility in controlling the MOSFET. They also feature two separate outputs working in complementary mode, offering flexibility in controlling both turn-on and turn-off switching speeds.

The ICs have internal logic circuitry that prevents shoot-through during output-state changes. The logic inputs are protected against voltage spikes up to +16V, regardless of V+ voltage. Propagation delay time is minimized and matched between the inverting and noninverting inputs. The ICs have a very fast switching time, combined with short propagation delays (12ns typ), making them ideal for high-frequency circuits. The ICs operate from a +4V to +14V single power supply and typically consume 0.5mA of supply current. The MAX15070A has standard TTL input logic levels, while the MAX15070B has CMOS-like high-noise-margin (HNM) input logic levels.

Both ICs are available in a 6-pin SOT23 package and operate over the -40°C to +125°C temperature range.

### Applications

- Power MOSFET Switching
- Switch-Mode Power Supplies
- DC-DC Converters
- Motor Control
- Power-Supply Modules

### Typical Operating Circuit

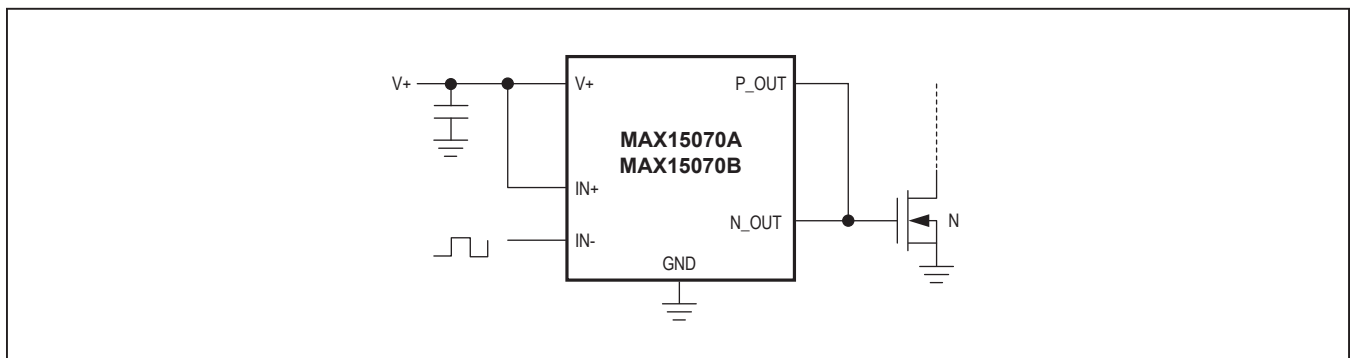

### Features

- Independent Source and Sink Outputs
- +4V to +14V Single Power-Supply Range
- 7A Peak Sink Current
- 3A Peak Source Current
- Inputs Rated to +14V Regardless of V+ Voltage
- 12ns Propagation Delay
- Matched Delays Between Inverting and Noninverting Inputs Within 500ps
- HNM or TTL Logic-Level Inputs
- Low-Input Capacitance: 10pF (typ)
- Thermal-Shutdown Protection
- Small SOT23 Package Allows Routing PCB Traces Underneath
- -40°C to +125°C Operating Temperature Range

Ordering Information appears at end of data sheet.

### Absolute Maximum Ratings

(Voltages referenced to GND.)

V+, IN+, IN-	-0.3V to +16V
N_OUT, P_OUT	-0.3V to (V+ + 0.3V)
N_OUT Continuous Output Current (Note 1)	-200mA
P_OUT Continuous Output Current (Note 1)	+125mA
Continuous Power Dissipation (T <sub>A</sub> = +70°C)	
SOT23 (derate 8.7mW/°C above +70°C)	696mW*

Operating Temperature Range	-40°C to +125°C
Junction Temperature	+150°C
Storage Temperature Range	-65°C to +150°C
Lead Temperature (soldering, 10s)	+300°C
Soldering Temperature (reflow)	+260°C

\*As per JEDEC 51 standard.

**Note 1:** Continuous output current is limited by the power dissipation of the package.

*Stresses beyond those listed under "Absolute Maximum Ratings" may cause permanent damage to the device. These are stress ratings only, and functional operation of the device at these or any other conditions beyond those indicated in the operational sections of the specifications is not implied. Exposure to absolute maximum rating conditions for extended periods may affect device reliability.*

### Package Information

#### 6 SOT23

Package Code	U6+1A
Outline Number	<a href="#">21-0058</a>
Land Pattern Number	<a href="#">90-0175</a>
<b>THERMAL RESISTANCE, FOUR-LAYER BOARD</b>	
Junction to Ambient (θ <sub>JA</sub> )	115°C/W
Junction to Case (θ <sub>JC</sub> )	80°C/W

For the latest package outline information and land patterns (footprints), go to [www.maximintegrated.com/packages](http://www.maximintegrated.com/packages). Note that a "+", "#", or "-" in the package code indicates RoHS status only. Package drawings may show a different suffix character, but the drawing pertains to the package regardless of RoHS status.

Package thermal resistances were obtained using the method described in JEDEC specification JESD51-7, using a four-layer board. For detailed information on package thermal considerations, refer to <http://www.maximintegrated.com/thermal-tutorial>.

## Electrical Characteristics

(V+ = +12V, C<sub>L</sub> = 0F, T<sub>A</sub> = T<sub>J</sub> = -40°C to +125°C, unless otherwise noted. Typical values are at T<sub>A</sub> = +25°C. Parameters specified at V+ = +4.5V apply to the MAX15070A only; see Figure 1.) (Note 2)

PARAMETER	SYMBOL	CONDITIONS	MIN	TYP	MAX	UNITS
<b>POWER SUPPLY (V+)</b>						
Input Voltage Range		MAX15070A	4		14	V
		MAX15070B	6		14	
Undervoltage Lockout	V <sub>UVLO</sub>	V+ rising	3.3	3.45	3.6	V
Undervoltage-Lockout Hysteresis				200		mV
Undervoltage Lockout to Output Rising Delay		V+ rising		100		μs
Undervoltage Lockout to Output Falling Delay		V+ falling		2		μs
Supply Current	I <sub>V+</sub>	V+ = 14V, no switching		0.5	1	mA
		V+ = 14V, switching at 1MHz		2.3		
<b>n-CHANNEL OUTPUT (N_OUT)</b>						
N_OUT Resistance	R <sub>N_OUT</sub>	V+ = +12V, I <sub>N_OUT</sub> = -100mA	T <sub>A</sub> = +25°C	0.256	0.32	Ω
			T <sub>A</sub> = +125°C		0.45	
		V+ = +4.5V, I <sub>N_OUT</sub> = -100mA	T <sub>A</sub> = +25°C	0.268	0.33	
			T <sub>A</sub> = +125°C		0.465	
Power-Off Pulldown Resistance		V+ = unconnected, I <sub>N_OUT</sub> = -1mA, T <sub>A</sub> = +25°C		1.3	1.9	kΩ
Output Bias Current	I <sub>BIASN</sub>	V <sub>N_OUT</sub> = V+		6	11	μA
Peak Output Current	I <sub>PEAKN</sub>	C <sub>L</sub> = 22nF		7.0		A
<b>p-CHANNEL OUTPUT (P_OUT)</b>						
P_OUT Resistance	R <sub>P_OUT</sub>	V+ = +12V, I <sub>P_OUT</sub> = 100mA	T <sub>A</sub> = +25°C	0.88	1.2	Ω
			T <sub>A</sub> = +125°C		1.7	
		V+ = +4.5V, I <sub>P_OUT</sub> = 100mA	T <sub>A</sub> = +25°C	0.91	1.25	
			T <sub>A</sub> = +125°C		1.75	
Output Leakage Current	I <sub>LEAKP</sub>	V <sub>P_OUT</sub> = 0V		0.01	1	μA
Peak Output Current	I <sub>PEAKP</sub>	C <sub>L</sub> = 22nF		3.0		A
<b>LOGIC INPUTS (IN+, IN-)</b>						
Logic-High Input Voltage	V <sub>IH</sub>	MAX15070A	2.0			V
		MAX15070B	4.25			
Logic-Low Input Voltage	V <sub>IL</sub>	MAX15070A			0.8	V
		MAX15070B			2.0	
Logic-Input Hysteresis	V <sub>HYS</sub>	MAX15070A		0.2		V
		MAX15070B		0.9		
Logic-Input Leakage Current		V <sub>IN+</sub> = V <sub>IN-</sub> = 0V or V+, MAX15070A		0.02		μA
Logic-Input Bias Current		V <sub>IN+</sub> = V <sub>IN-</sub> = 0V or V+, MAX15070B		10		
Input Capacitance				10		pF

**Electrical Characteristics (continued)**

(V+ = +12V, C<sub>L</sub> = 0F, T<sub>A</sub> = T<sub>J</sub> = -40°C to +125°C, unless otherwise noted. Typical values are at T<sub>A</sub> = +25°C. Parameters specified at V+ = +4.5V apply to the MAX15070A only; see Figure 1.) (Note 2)

PARAMETER	SYMBOL	CONDITIONS	MIN	TYP	MAX	UNITS
<b>SWITCHING CHARACTERISTICS FOR V+ = +12V (Figure 1)</b>						
Rise Time	t <sub>R</sub>	C <sub>L</sub> = 1nF		6		ns
		C <sub>L</sub> = 5nF		22		
		C <sub>L</sub> = 10nF		36		
Fall Time	t <sub>F</sub>	C <sub>L</sub> = 1nF		4		ns
		C <sub>L</sub> = 5nF		11		
		C <sub>L</sub> = 10nF		17		
Turn-On Delay Time	t <sub>D-ON</sub>	C <sub>L</sub> = 1nF (Note 3)	7	11	17	ns
Turn-Off Delay Time	t <sub>D-OFF</sub>	C <sub>L</sub> = 1nF (Note 3)	7	12	18	ns
Break-Before-Make Time	t <sub>BBM</sub>			2		ns
<b>SWITCHING CHARACTERISTICS FOR V+ = +4.5V (MAX15070A only) (Figure 1)</b>						
Rise Time	t <sub>R</sub>	C <sub>L</sub> = 1nF		5		ns
		C <sub>L</sub> = 5nF		16		
		C <sub>L</sub> = 10nF		25		
Fall Time	t <sub>F</sub>	C <sub>L</sub> = 1nF		4		ns
		C <sub>L</sub> = 5nF		10		
		C <sub>L</sub> = 10nF		14		
Turn-On Delay Time	t <sub>D-ON</sub>	C <sub>L</sub> = 1nF (Note 3)	7	13	21	ns
Turn-Off Delay Time	t <sub>D-OFF</sub>	C <sub>L</sub> = 1nF (Note 3)	7	14	22	ns
Break-Before-Make Time	t <sub>BBM</sub>			2		ns
<b>THERMAL CHARACTERISTICS</b>						
Thermal Shutdown		Temperature rising (Note 3)		166		°C
Thermal-Shutdown Hysteresis		(Note 3)		13		°C

**Note 2:** Limits are 100% tested at T<sub>A</sub> = +25°C. Limits over operating temperature range are guaranteed through correlation using the statistical quality control (SQC) method.

**Note 3:** Design guaranteed by bench characterization. Limits are not production tested.

Typical Operating Characteristics

( $C_L = 1000\text{pF}$ ,  $T_A = +25^\circ\text{C}$ , unless otherwise noted. See Figure 1.)

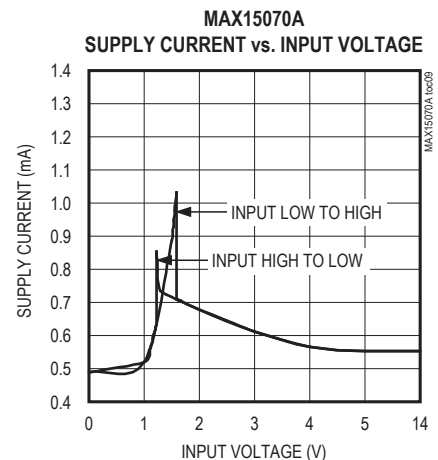
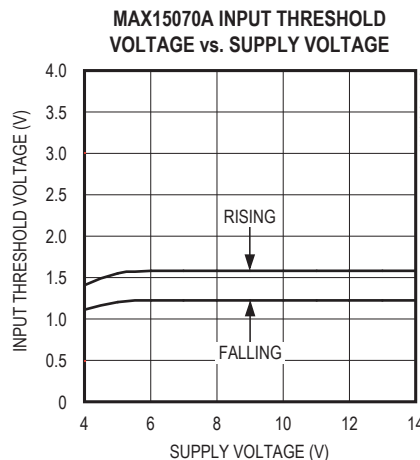
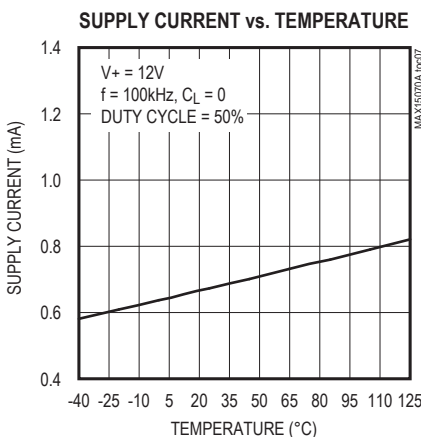
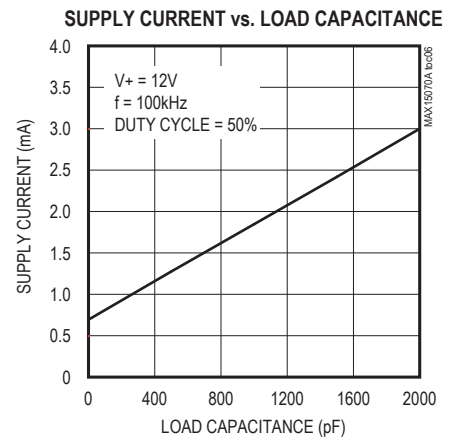
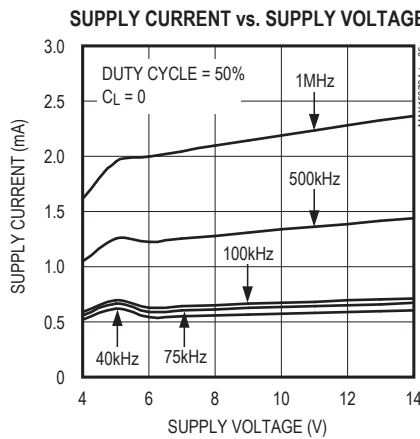
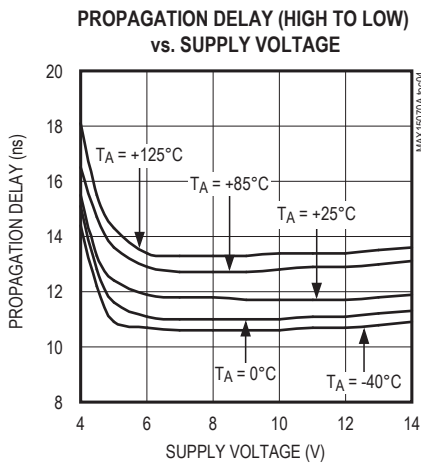
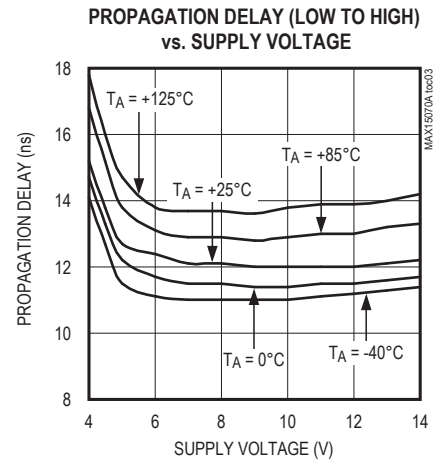
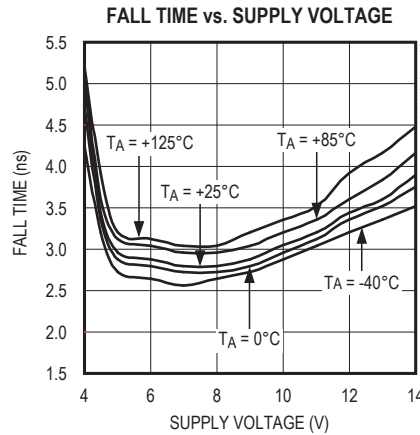
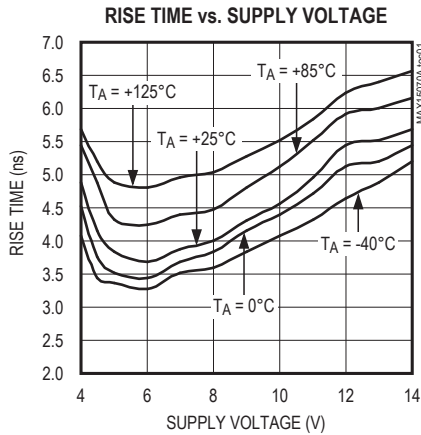

Typical Operating Characteristics (continued)

( $C_L = 1000\text{pF}$ ,  $T_A = +25^\circ\text{C}$ , unless otherwise noted. See Figure 1.)

INPUT VOLTAGE vs. OUTPUT VOLTAGE  
( $V_+ = +4\text{V}$ ,  $C_L = 5000\text{pF}$ )

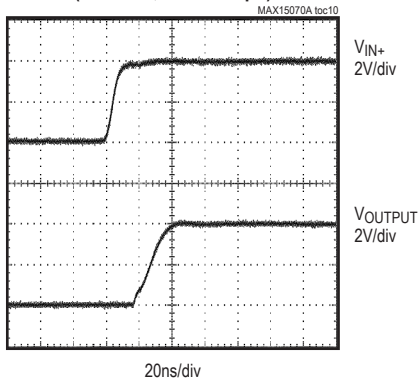

INPUT VOLTAGE vs. OUTPUT VOLTAGE  
( $V_+ = +4\text{V}$ ,  $C_L = 10,000\text{pF}$ )

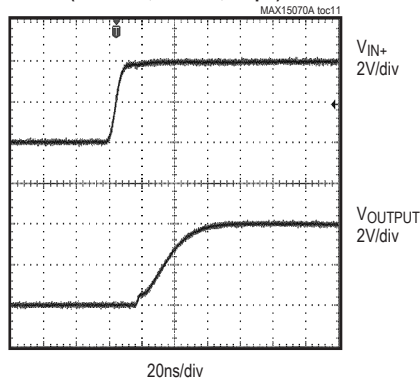

INPUT VOLTAGE vs. OUTPUT VOLTAGE  
( $V_+ = +4\text{V}$ ,  $C_L = 5000\text{pF}$ )

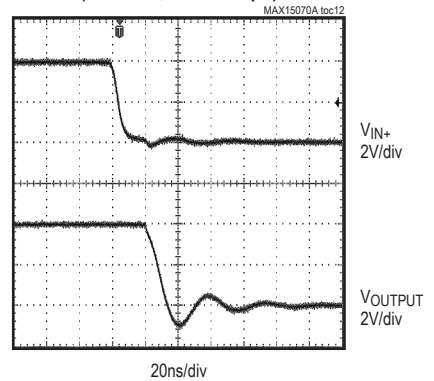

INPUT VOLTAGE vs. OUTPUT VOLTAGE  
( $V_+ = +4\text{V}$ ,  $C_L = 10,000\text{pF}$ )

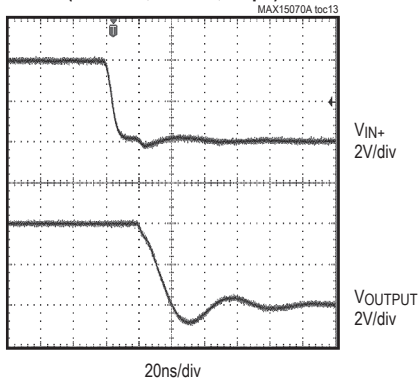

INPUT VOLTAGE vs. OUTPUT VOLTAGE  
( $V_+ = +14\text{V}$ ,  $C_L = 5000\text{pF}$ )

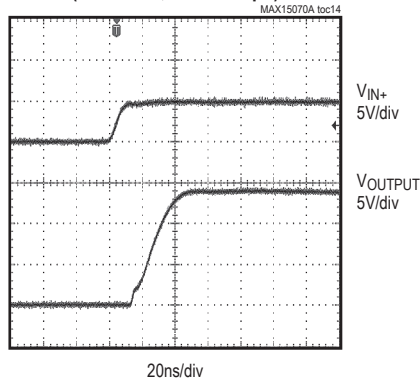

INPUT VOLTAGE vs. OUTPUT VOLTAGE  
( $V_+ = +14\text{V}$ ,  $C_L = 10,000\text{pF}$ )

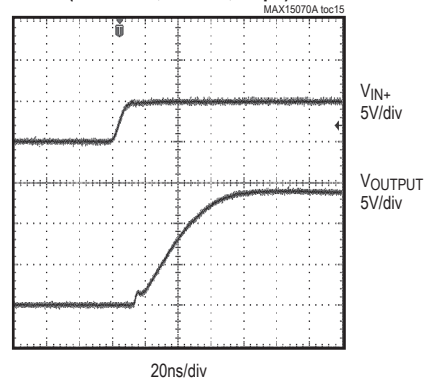

INPUT VOLTAGE vs. OUTPUT VOLTAGE  
( $V_+ = +14\text{V}$ ,  $C_L = 5000\text{pF}$ )

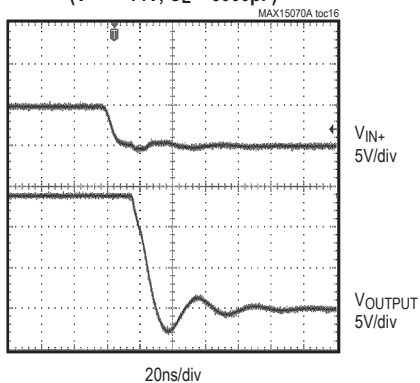

INPUT VOLTAGE vs. OUTPUT VOLTAGE  
( $V_+ = +14\text{V}$ ,  $C_L = 10,000\text{pF}$ )

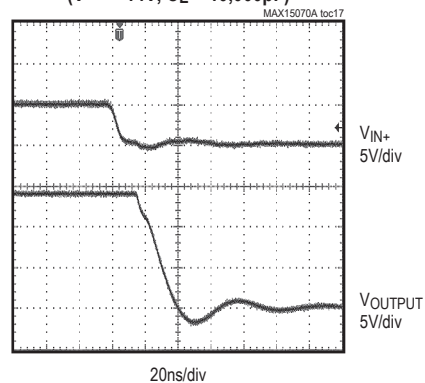

### Pin Configuration

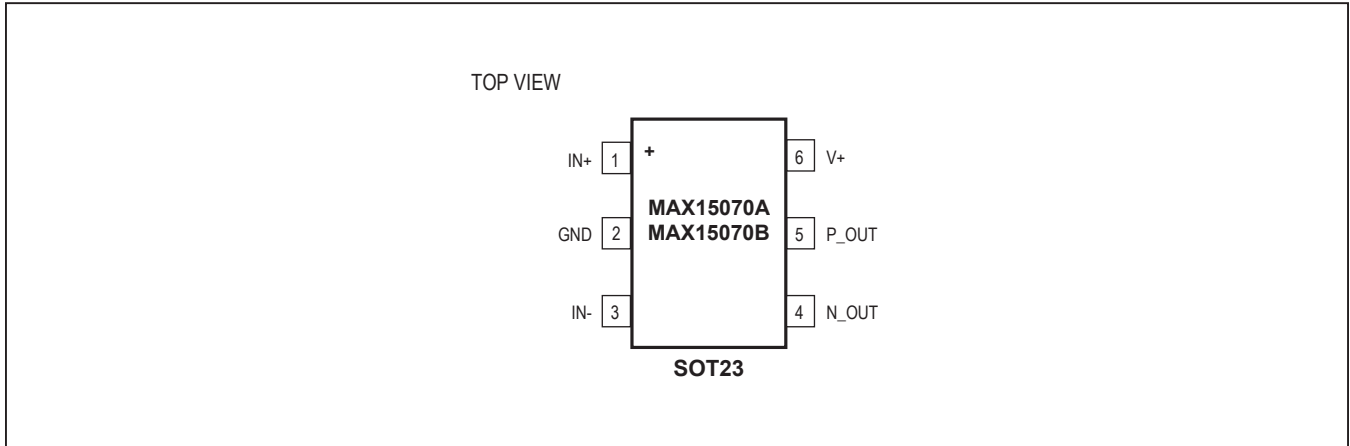

### Pin Description

PIN	NAME	FUNCTION
1	IN+	Noninverting Logic Input. Connect IN+ to V+ when not used.
2	GND	Ground
3	IN-	Inverting Logic Input. Connect IN- to GND when not used.
4	N_OUT	Driver Sink Output. Open-drain n-channel output. Sinks current for power MOSFET turn-off.
5	P_OUT	Driver Source Output. Open-drain p-channel output. Sources current for power MOSFET turn-on.
6	V+	Power-Supply Input. Bypass V+ to GND with a 1µF low-ESR ceramic capacitor.

### Functional Diagram

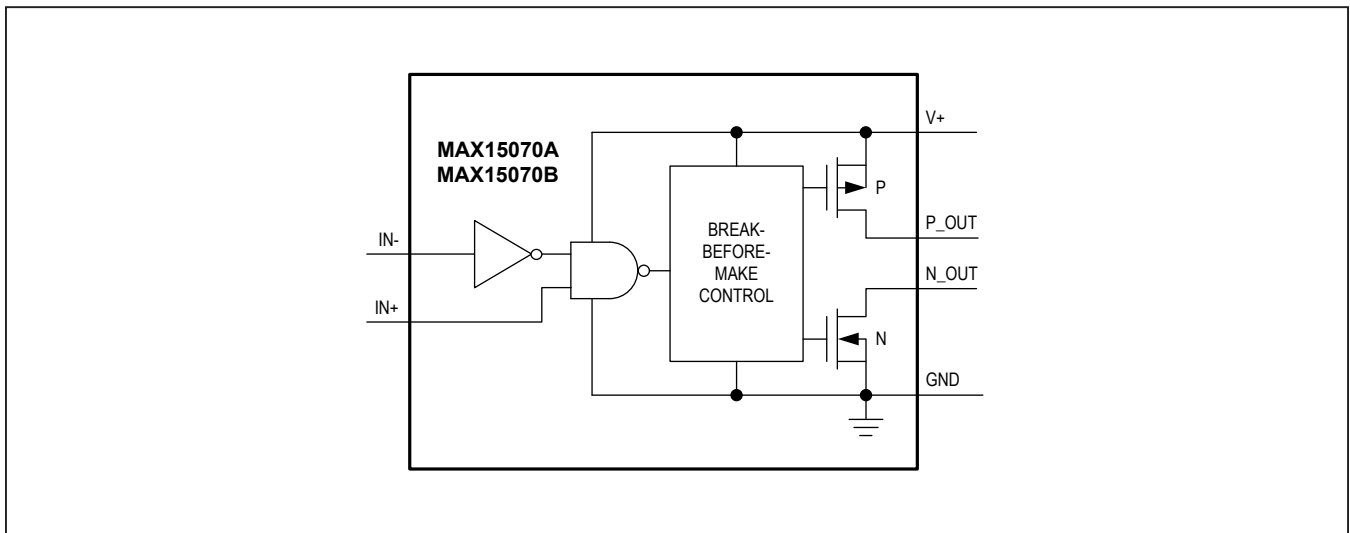

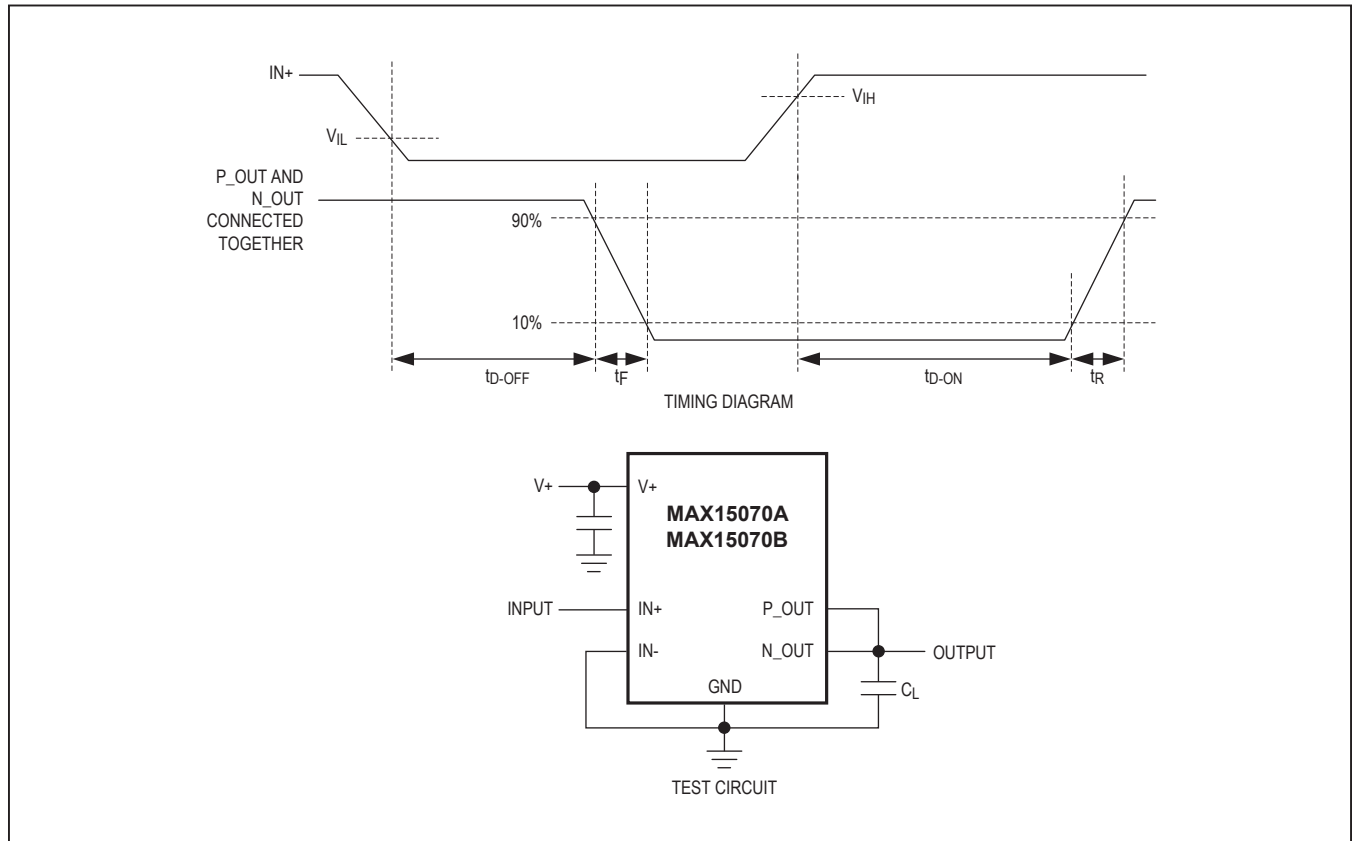

Figure 1. Timing Diagram and Test Circuit

## Detailed Description

### Logic Inputs

The MAX15070A/MAX15070Bs' logic inputs are protected against voltage spikes up to +16V, regardless of the V+ voltage. The low 10pF input capacitance of the inputs reduces loading and increases switching speed. These ICs have two inputs that give the user greater flexibility in controlling the MOSFET. Table 1 shows all possible input combinations. The difference between the MAX15070A and the MAX15070B is the input threshold voltage. The MAX15070A has TTL logic-level thresholds, while the

Table 1. Truth Table

IN+	IN-	p-CHANNEL	n-CHANNEL
L	L	Off	On
L	H	Off	On
H	L	On	Off
H	H	Off	On

L = Logic-low, H = Logic-high.

MAX15070B has HNM (CMOS-like) logic-level thresholds (see the *Electrical Characteristics*). Connect IN+ to V+ or IN- to GND when not used. Alternatively, the unused input can be used as an on/off control input (Table 1).

### Undervoltage Lockout (UVLO)

When V+ is below the UVLO threshold, the n-channel is on and the p-channel is off, independent of the state of the inputs. The UVLO is typically 3.45V with 200mV typical hysteresis to avoid chattering. A typical falling delay of 2μs makes the UVLO immune to narrow negative transients in noisy environments.

### Driver Outputs

The ICs provide two separate outputs. One is an open-drain p-channel, the other an open-drain n-channel. They have distinct current sourcing/sinking capabilities to independently control the rise and fall times of the MOSFET gate. Add a resistor in series with P\_OUT/N\_OUT to slow the corresponding rise/fall time of the MOSFET gate.



## Applications Information

### Supply Bypassing, Device Grounding, and Placement

Ample supply bypassing and device grounding are extremely important because when large external capacitive loads are driven, the peak current at the V+ pin can approach 3A, while at the GND pin, the peak current can approach 7A. V<sub>CC</sub> drops and ground shifts are forms of negative feedback for inverters and, if excessive, can cause multiple switching when the IN- input is used and the input slew rate is low. The device driving the input should be referenced to the ICs' GND pin, especially when the IN- input is used. Ground shifts due to insufficient device grounding can disturb other circuits sharing the same AC ground return path. Any series inductance in the V+, P\_OUT, N\_OUT, and/or GND paths can cause oscillations due to the very high di/dt that results when the ICs are switched with any capacitive load. A 1μF or larger value ceramic capacitor is recommended, bypassing V+ to GND and placed as close as possible to the pins. When driving very large loads (e.g., 10nF) at minimum rise time, 10μF or more of parallel storage capacitance is recommended. A ground plane is highly recommended to minimize ground return resistance and series inductance. Care should be taken to place the ICs as close as possible to the external MOSFET being driven to further minimize board inductance and AC path resistance.

### Power Dissipation

Power dissipation of the ICs consists of three components, caused by the quiescent current, capacitive charge and discharge of internal nodes, and the output current (either capacitive or resistive load). The sum of these components must be kept below the maximum power-dissipation limit of the package at the operating temperature.

The quiescent current is 0.5mA typical. The current required to charge and discharge the internal nodes is frequency dependent (see the *Typical Operating Characteristics*).

For capacitive loads, the total power dissipation is approximately:

$$P = C_{LOAD} \times (V+)^2 \times FREQ$$

where C<sub>LOAD</sub> is the capacitive load, V+ is the supply voltage, and FREQ is the switching frequency.

## Layout Information

The ICs' MOSFET drivers source and sink large currents to create very fast rise and fall edges at the gate of the switching MOSFET. The high di/dt can cause unacceptable ringing if the trace lengths and impedances are not well controlled. The following PCB layout guidelines are recommended when designing with the ICs:

- Place one or more 1μF decoupling ceramic capacitor(s) from V+ to GND as close as possible to the IC. At least one storage capacitor of 10μF (min) should be located on the PCB with a low resistance path to the V+ pin of the ICs. There are two AC current loops formed between the IC and the gate of the MOSFET being driven. The MOSFET looks like a large capacitance from gate to source when the gate is being pulled low. The active current loop is from N\_OUT of the ICs to the MOSFET gate to the MOSFET source and to GND of the ICs. When the gate of the MOSFET is being pulled high, the active current loop is from P\_OUT of the ICs to the MOSFET gate to the MOSFET source to the GND terminal of the decoupling capacitor to the V+ terminal of the decoupling capacitor and to the V+ terminal of the ICs. While the charging current loop is important, the discharging current loop is critical. It is important to minimize the physical distance and the impedance in these AC current paths.
- In a multilayer PCB, the component surface layer surrounding the ICs should consist of a GND plane containing the discharging and charging current loops.

## Ordering Information

PART	INPUT LOGIC LEVELS	PIN-PACKAGE
MAX15070AAUT+	TTL	6 SOT23
MAX15070AAUT/V+	TTL	6 SOT23
MAX15070BAUT+	HNM	6 SOT23

**Note:** All devices are specified over the -40°C to +125°C operating temperature range.

+Denotes a lead(Pb)-free/RoHS-compliant package.

/V Denotes an automotive-qualified part.

## Chip Information

PROCESS: BiCMOS

## Revision History

REVISION NUMBER	REVISION DATE	DESCRIPTION	PAGES CHANGED
0	11/10	Initial release	—
1	11/11	Added MAX15070AAVT/V+ to data sheet	1, 2, 3, 8, 9
2	8/12	Removed <i>Evaluation Kit Available</i> banner	1
3	5/13	Updated <i>Ordering Information</i>	1
4	11/19	Updated the <i>Package Information</i> table	2

For pricing, delivery, and ordering information, please visit Maxim Integrated's online storefront at <https://www.maximintegrated.com/en/storefront/storefront.html>.

Maxim Integrated cannot assume responsibility for use of any circuitry other than circuitry entirely embodied in a Maxim Integrated product. No circuit patent licenses are implied. Maxim Integrated reserves the right to change the circuitry and specifications without notice at any time. The parametric values (min and max limits) shown in the Electrical Characteristics table are guaranteed. Other parametric values quoted in this data sheet are provided for guidance.