

3.5V to 14V, 1.0A 1ch Synchronous Buck Converter Integrated MOSFET

BD8313HFN

General Description

The BD8313HFN can produce stepped-down voltage from a power supply composed of 4 batteries, which can be Li2cell, Li3cell, etc., or from a 5V/12V fixed power supply line. Output voltages include 1.2V, 1.8V, 3.3V, or 5.0V. This IC allows easy production of a compact power supply since its high operating frequency of 1.0MHz requires small-sized external inductor and capacitor and the phase compensation components are integrated in the chip. The built-in synchronous rectification switches are capable of withstanding 15V.

Features

- Built-In Pch/Nch Synchronous Rectification SW Capable of Withstanding 1.2 A/15V.
- Built-In Phase Compensation Device between Input and Output of Error AMP.
- Built-In Soft-Start Function.
- Built-In Short-Circuit Protection with Timer

Application

For Portable Equipments like DSC/DVC Powered by 4 Dry Batteries or Li2cell and Li3cell, or General Consumer-Equipment with 5V/12V Lines

Key Specifications

- Input Voltage Range: +3.5V to +14V
- Output Voltage Range: +1.2V to +12V
- Output Current: 1.0A(Max)
- Switching Frequency: 1.0MHz(Typ)
- Pch FET ON-Resistance: 450mΩ(Typ)
- Nch FET ON-Resistance: 300mΩ(Typ)
- Standby Current: 0μA(Typ)
- Operating Temperature Range: -25°C to +85°C

Package

W(Typ) x D(Typ) x H(Max)



Typical Application Circuit

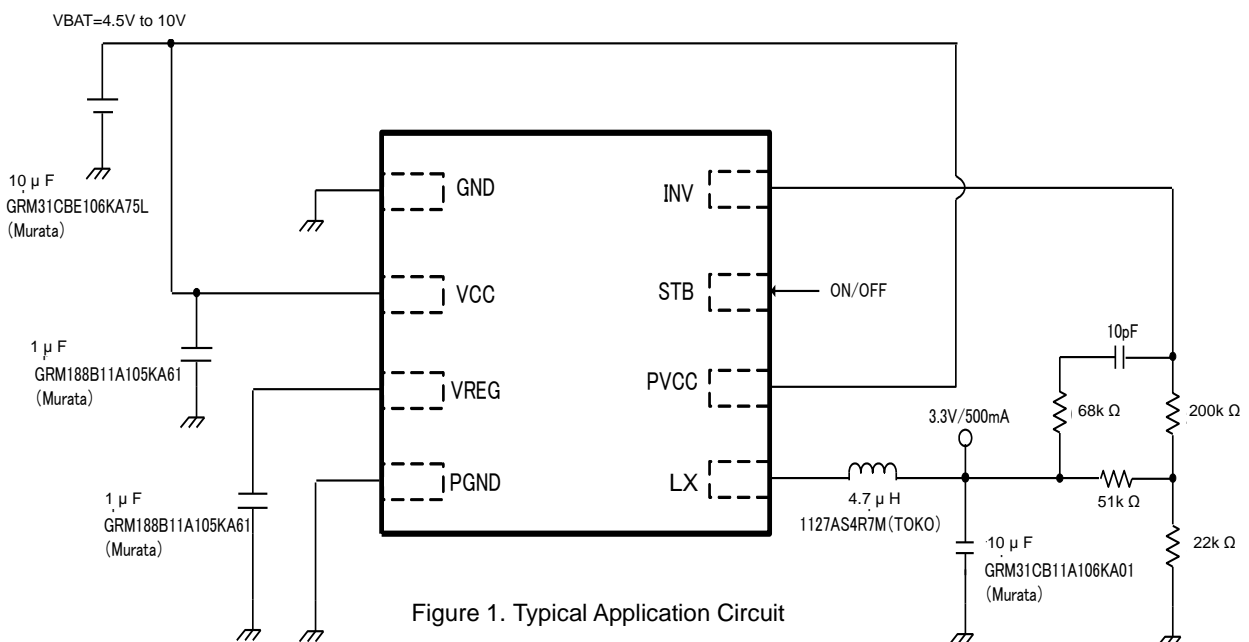

Figure 1. Typical Application Circuit

Pin Configuration

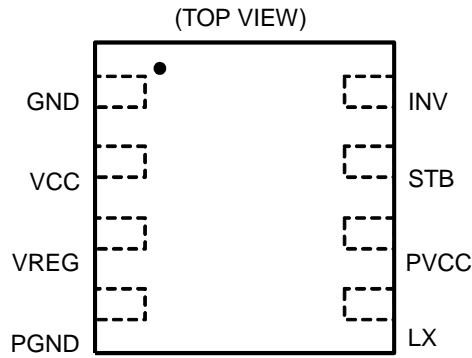

Figure 2. Pin Configuration

Pin Description

Pin No.	Pin Name	Function
1	GND	Ground pin
2	VCC	Control circuit power supply pin
3	VREG	5V output pin of regulator for internal circuit
4	PGND	Power transistor ground pin
5	LX	Switching output pin (pin for external coil)
6	PVCC	Power transistor supply pin
7	STB	ON/OFF pin
8	INV	Error AMP input pin

Block Diagram

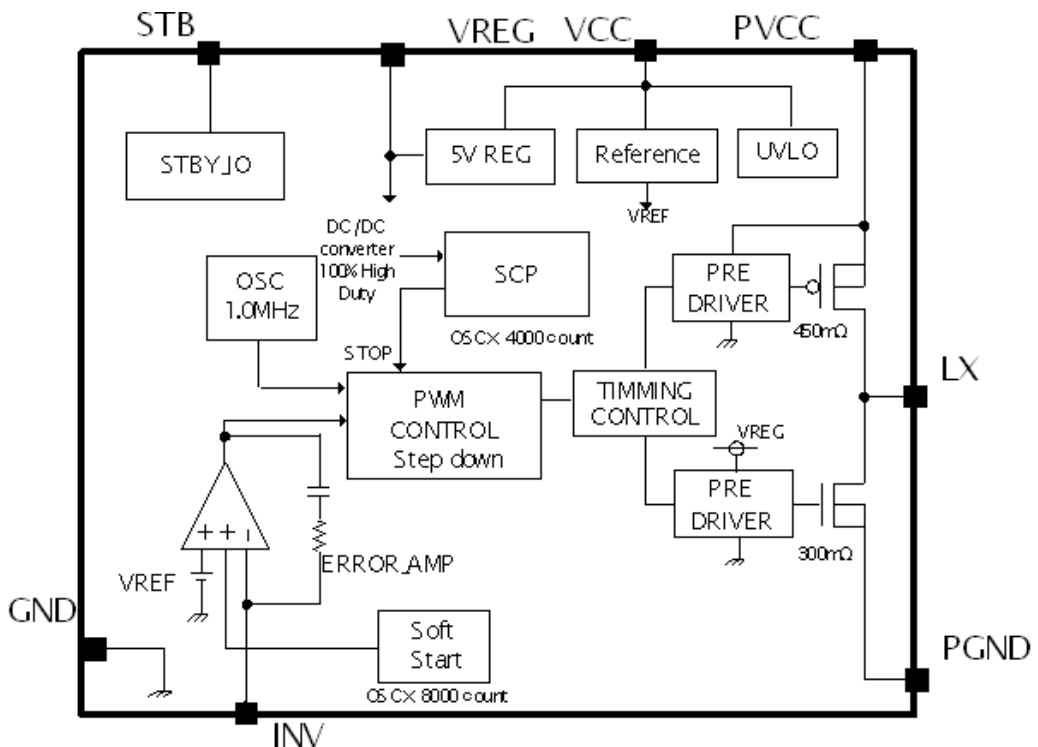

Figure 3. Block Diagram

Description of Blocks

- (1) Reference
This is the block that generates the 1V reference voltage for the ERROR AMP.
- (2) 5V REG
This block produces a 5V regulated voltage supply for the internal analog circuit. BD8313HFN is equipped with this regulator for the purpose of protecting the internal circuit from high voltages. The output of this block decreases when VCC is less than 5V, increasing the PMOS ON resistance and decreasing the DC/DC converter's power efficiency and maximum output current (Please see data in Figures 15, 16, 17, and 18).
- (3) UVLO
This circuit prevents malfunction of the internal circuit when input voltage is not enough like, while the input supply is rising or when the power supply voltage is low. The UVLO circuit monitors VCC and turns OFF all output FETs and DC/DC converter output when VCC is lower than 2.9V. It also resets the timer latch of the built-in SCP and soft-start circuits.
- (4) SCP
The short-circuit protection circuit of this IC has a timer latch system. When the DC/DC converter has a duty cycle of 100%, the built-in SCP circuit starts counting. The internal counter is synchronized with the frequency of OSC. The latch circuit turns OFF the DC/DC converter's output after about 4.0 milliseconds or when the counter has counted about 4000 clock pulses. To reset the latch circuit, turn the STB input OFF and ON once or turn the power supply OFF and then ON.
- (5) OSC
This circuit generates a saw tooth wave with operating frequency fixed at 1.0MHz.
- (6) ERROR AMP
The Error Amplifier monitors the output voltage of the DC/DC converter and its output serves as a PWM control signal. The reference voltage for the ERROR AMP is 1.0V. Primary phase compensation components, 200pF and 62kΩ, are built-in and are placed between the inverting input and the output terminals of the ERROR AMP.
- (7) PWM COMP
This block is a voltage-to-pulse width converter for controlling the output voltage corresponding to an input voltage. The PWM COMP controls the pulse width of the driver's output by comparing the internal SLOPE wave with the ERROR AMP output voltage.
- (8) SOFT START
This circuit prevents inrush current during startup by making the output voltage of the DC/DC converter increase gradually. The soft start time is synchronized with the internal oscillator. Output voltage of the DC/DC converter reaches the set voltage after about 8000 clock pulses.
- (9) PRE DRIVER/TIMING CONTROL
This block is the CMOS inverter circuit for driving the built-in synchronous rectifier switches. The dead time of the synchronous switches for preventing feed-through is about 25ns.
- (10) STBY_IO
The voltage at STB (pin 7) determines whether the IC is ON or OFF. The IC is ON when STB is 2.5V or higher and OFF when STB pin is open or at 0V. STB pin is pulled down by an internal resistor which is approximately 400kΩ.
- (11) Pch/Nch FET SW
The built-in synchronous rectification switches are for switching the coil current of the DC/DC converter. The 450mΩ Pch FET switch and the 300mΩ Nch FET switch are capable of withstanding 15V. Since the current rating of the FETs is 1.2A, the output current, including the ripple current of the coil IC should not exceed this limit.

Absolute Maximum Ratings

Parameter	Symbol	Rating	Unit
Maximum Applied Power Voltage	V_{CC}, P_{VCC}	15	V
Maximum Input Current	I_{INMAX}	1.2	A
Power Dissipation	P_d	0.63 ^(Note 1)	W
Operating Temperature Range	T_{opr}	-25 to +85	°C
Storage Temperature Range	T_{stg}	-55 to +150	°C
Junction Temperature	T_{jmax}	+150	°C

(Note 1) When used at $T_a = 25^\circ\text{C}$ or more installed on a 70x70x1.6mm board, the rating is reduced by 5.04mW/°C.

(Note) These specifications are subject to change without advance notice for modifications and other reasons.

Caution: Operating the IC over the absolute maximum ratings may damage the IC. The damage can either be a short circuit between pins or an open circuit between pins and internal circuitry. Therefore, it is important to consider circuit protection measures, such as adding a fuse, in case the IC is operated over the absolute maximum ratings.

Recommended Operating Conditions

Parameter	Symbol	Rating	Unit
Power Supply Voltage	V_{CC}	3.5 to 14	V
Output Voltage	V_{OUT}	1.2 to 12	V

Electrical Characteristics (Unless otherwise specified, $T_a = 25^\circ\text{C}$, $V_{CC} = 7.4\text{V}$)

Parameter	Symbol	Limit			Unit	Conditions	
		Min	Typ	Max			
[Low Input Voltage Malfunction Prevention Circuit]							
Detection Threshold Voltage	V_{UV}	-	2.9	3.2	V	VREG monitor	
Hysteresis Range	ΔV_{UVHY}	100	200	300	mV		
[Oscillator]							
Oscillation Frequency	f_{OSC}	0.9	1.0	1.1	MHz		
[Regulator]							
Output Voltage	V_{REG}	4.65	5.0	5.35	V		
[Error AMP]							
INV Threshold Voltage	V_{INV}	0.99	1.00	1.01	V		
Input Bias Current	I_{INV}	-50	0	+50	nA	$V_{CC} = 12.0\text{V}$, $V_{INV} = 6.0\text{V}$	
Soft-Start Time	t_{SS}	4.8	8.0	11.1	msec		
[PWM Comparator]							
LX Max Duty ^(Note 2)	D_{MAX}	-	-	100	%		
[Output]							
PMOS ON-Resistance	R_{ONP}	-	450	600	mΩ		
NMOS ON-Resistance	R_{ONN}	-	300	420	mΩ		
Leak Current	I_{LEAK}	-1	0	+1	μA		
[STB]							
STB Pin Control Voltage	Operation	V_{STBH}	2.5	-	14	V	
	No-Operation	V_{STBL}	-0.3	-	+0.3	V	
STB Pin Pull-Down Resistance	R_{STB}	250	400	700	kΩ		
[Circuit Current]							
Standby Current	VCC Pin	I_{STB1}	-	-	1	μA	
	PVCC Pin	I_{STB2}	-	-	1	μA	
Circuit Current at Operating VCC	I_{CC1}	-	600	900	μA	$V_{INV} = 1.2\text{V}$	
Circuit Current at Operating PVCC	I_{CC2}	-	30	50	μA	$V_{INV} = 1.2\text{V}$	

(Note 2) 100% is MAX Duty as behavior of a PWM comparator. For the condition where High side PMOS is 100% ON-state because the input voltage is less than or equal to the output voltage, the SCP detector is activated and then the DC/DC converter operation stops.

Typical Performance Curves

(Unless otherwise specified, $T_a = 25^\circ\text{C}$, $V_{CC} = 7.4\text{V}$)

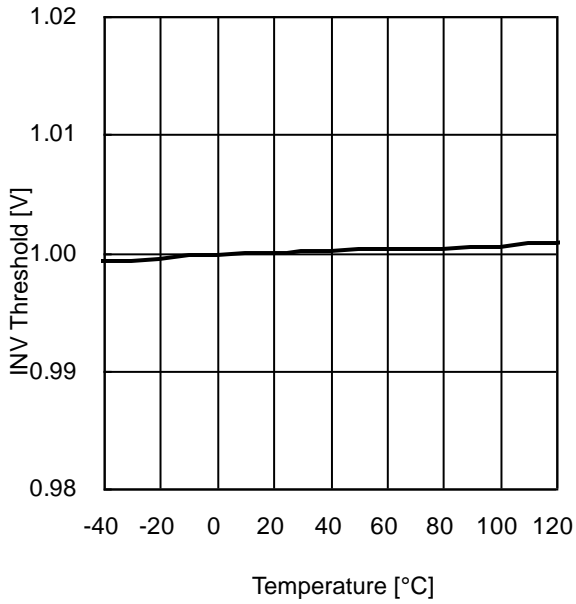

Figure 4. INV Threshold vs Temperature

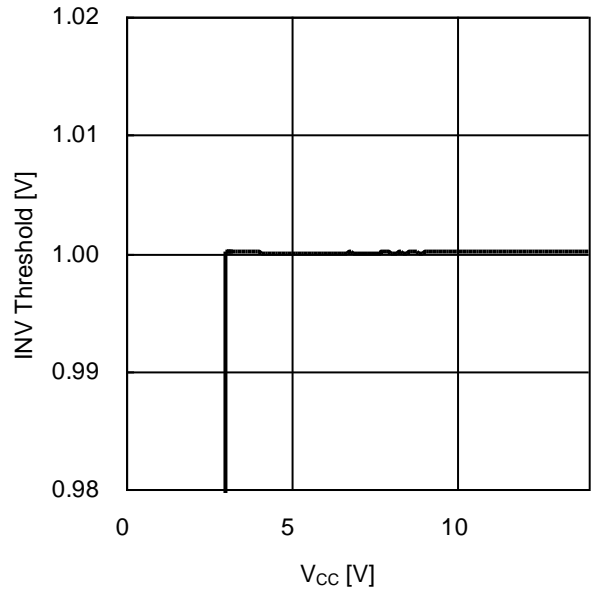

Figure 5. INV Threshold vs V_{CC}

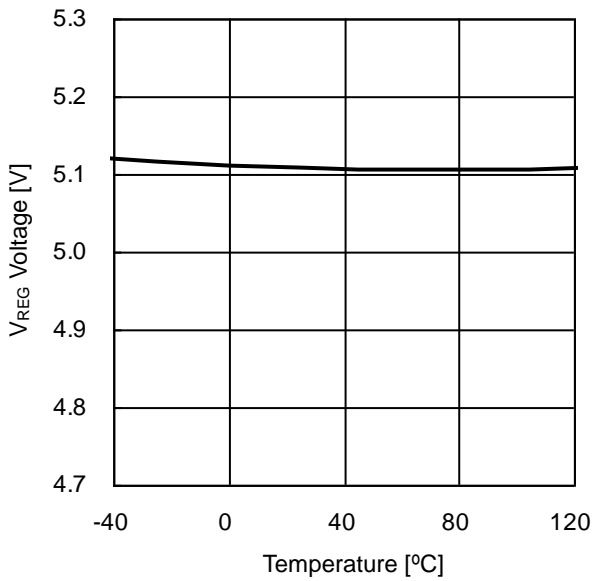

Figure 6. VREG Output vs Temperature

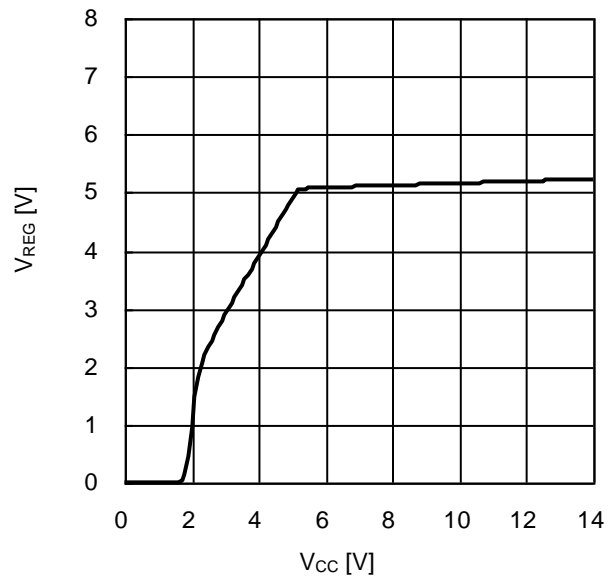

Figure 7. VREG Output vs V_{CC}

Typical Performance Curves - continued
 (Unless otherwise specified, $T_a = 25^\circ\text{C}$, $V_{CC} = 7.4\text{V}$)

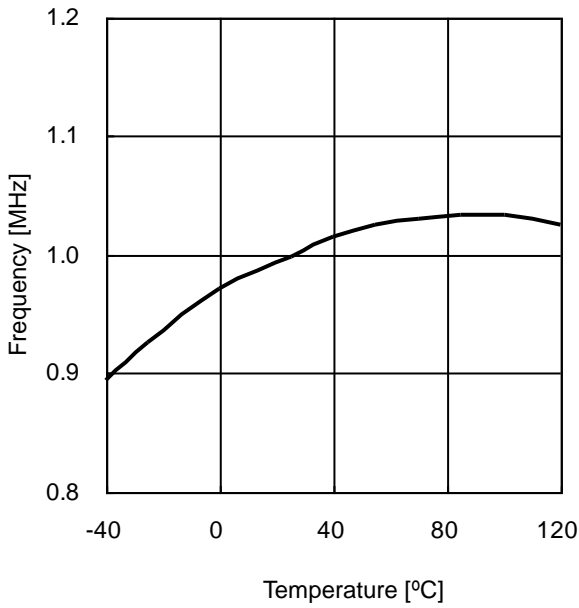

Figure 8. Frequency vs Temperature

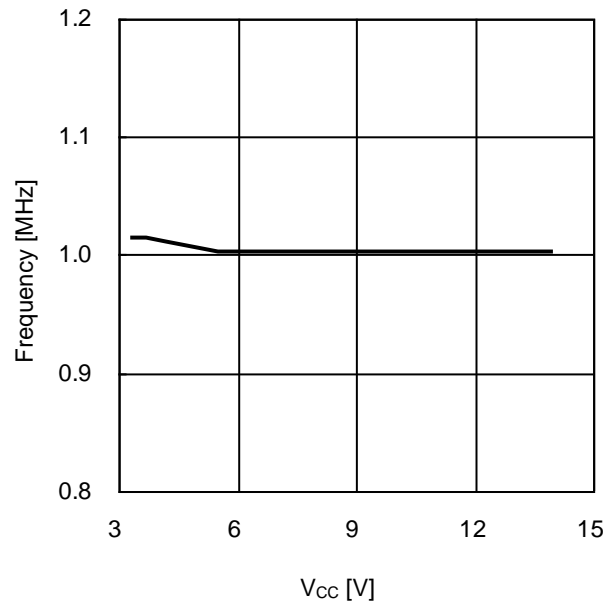

Figure 9. Frequency vs V_{CC}

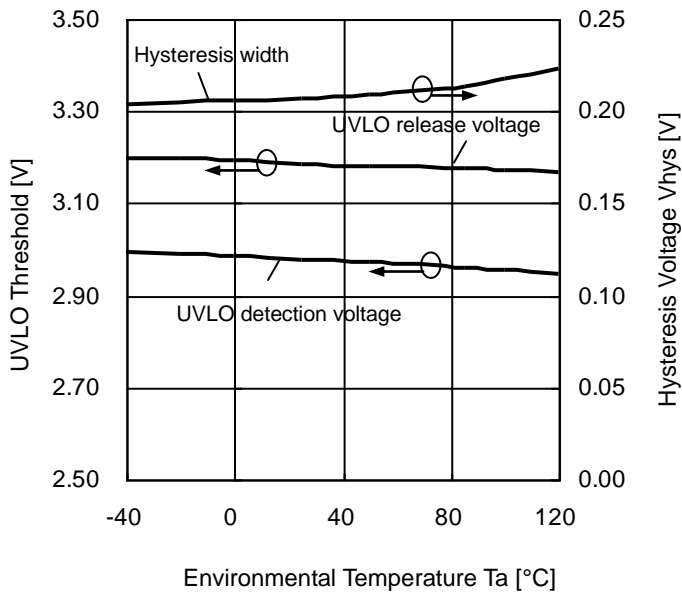

Figure 10. UVLO Threshold vs Environmental Temperature (UVLO Threshold)

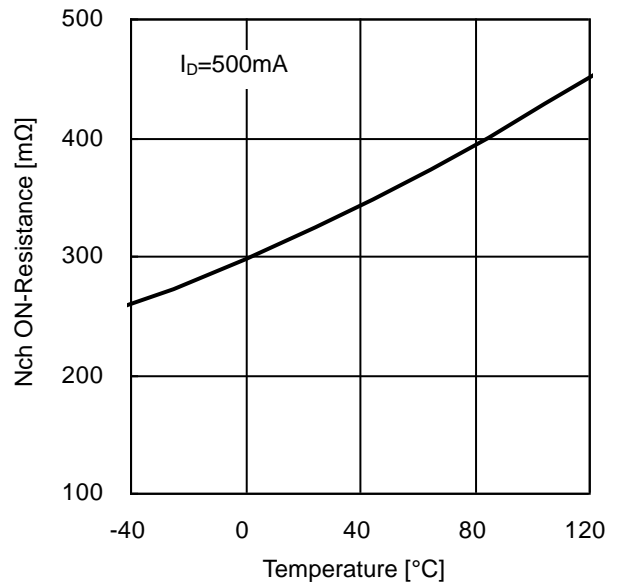

Figure 11. Nch FET ON-Resistance vs Temperature

Typical Performance Curves – continued
 (Unless otherwise specified, $T_a = 25^\circ\text{C}$, $V_{CC} = 7.4\text{V}$)

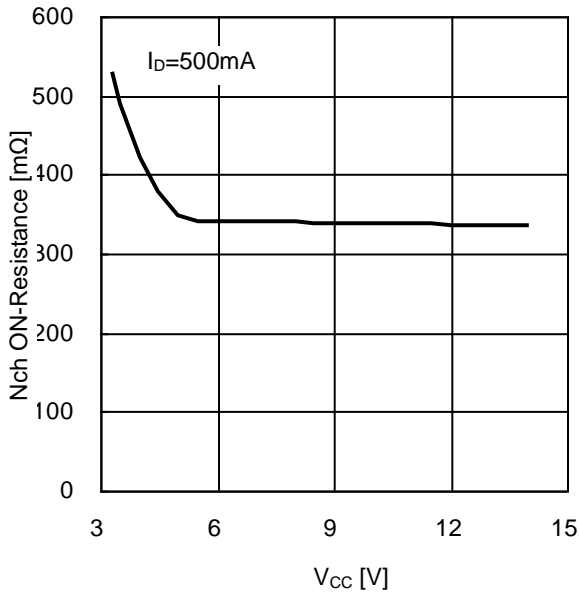

Figure 12. Nch FET ON-Resistance vs V_{CC}

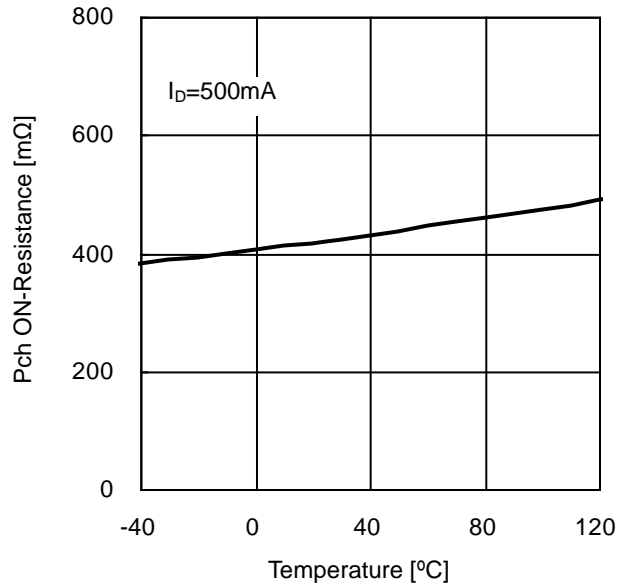

Figure 13. Pch FET ON-Resistance vs Temperature

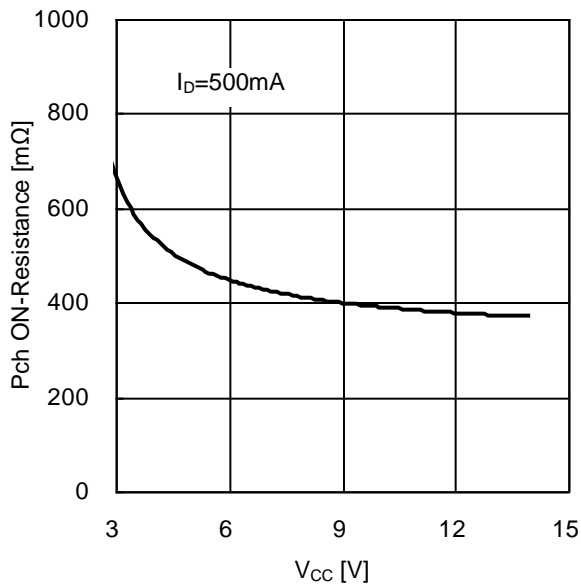

Figure 14. Pch FET ON-Resistance vs V_{CC}

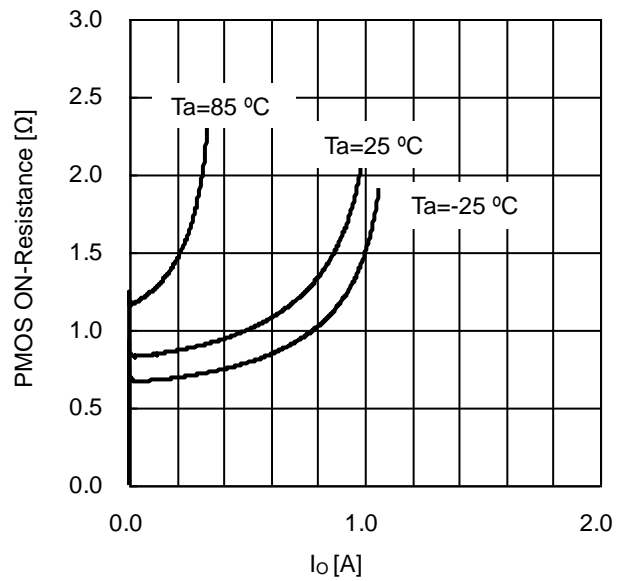

Figure 15. Pch FET ON-Resistance vs I_O
 (V_{CC}=3.5V)

Typical Performance Curves – continued
 (Unless otherwise specified, $T_a = 25^\circ\text{C}$, $V_{CC} = 7.4\text{V}$)

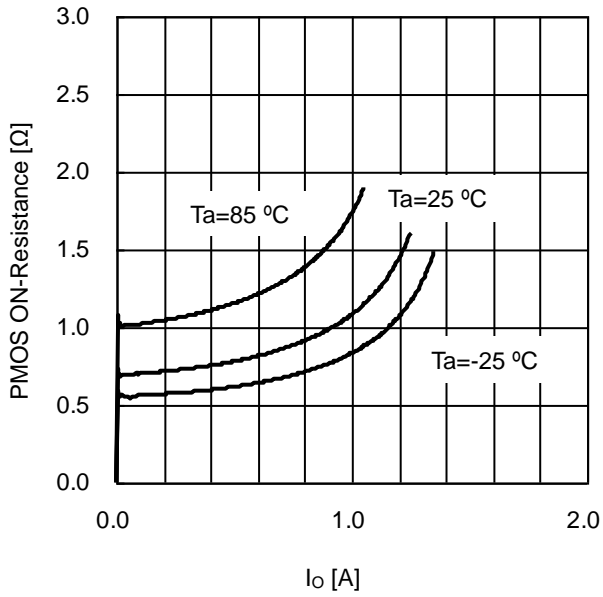

Figure 16. Pch FET ON Resistance vs I_o
 ($V_{CC}=4.0\text{V}$)

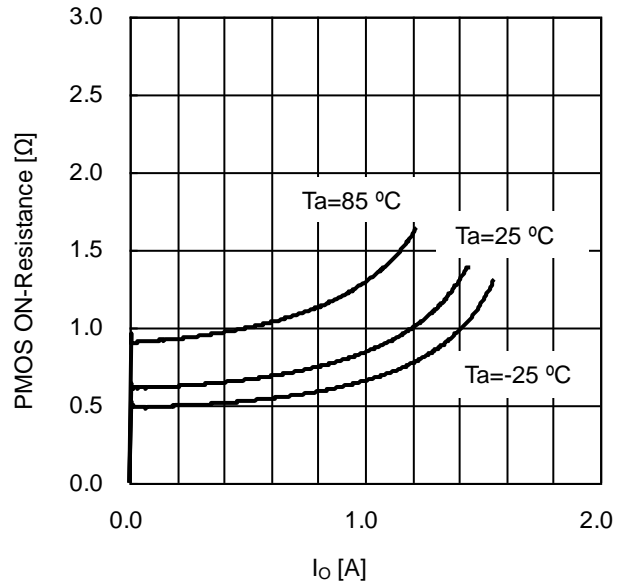

Figure 17. Pch FET ON-Resistance vs I_o
 ($V_{CC}=4.5\text{V}$)

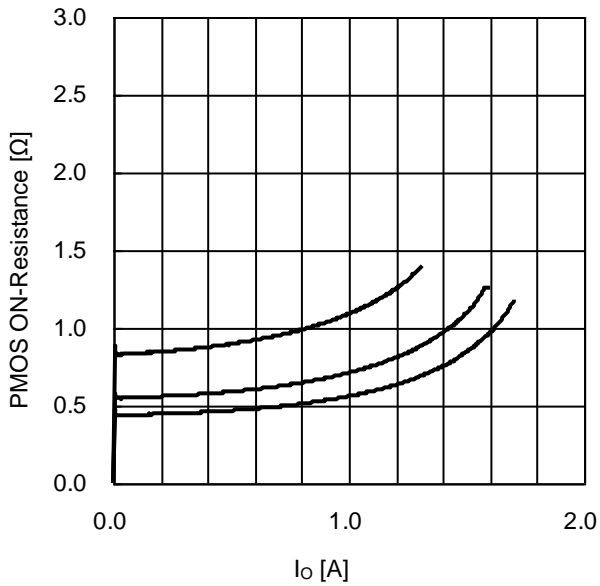

Figure 18. Pch FET ON-Resistance vs I_o
 ($V_{CC}=5.0\text{V}$)

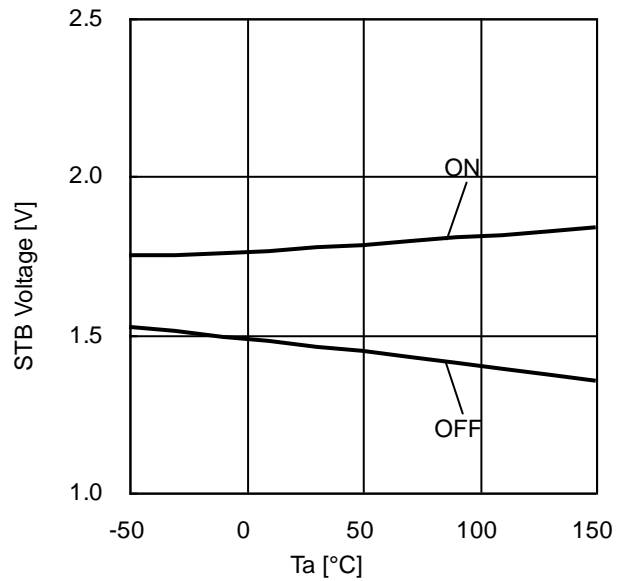

Figure 19. STB Threshold vs Temperature

Typical Performance Curves – continued
 (Unless otherwise specified, $T_a = 25^\circ\text{C}$, $V_{CC} = 7.4\text{V}$)

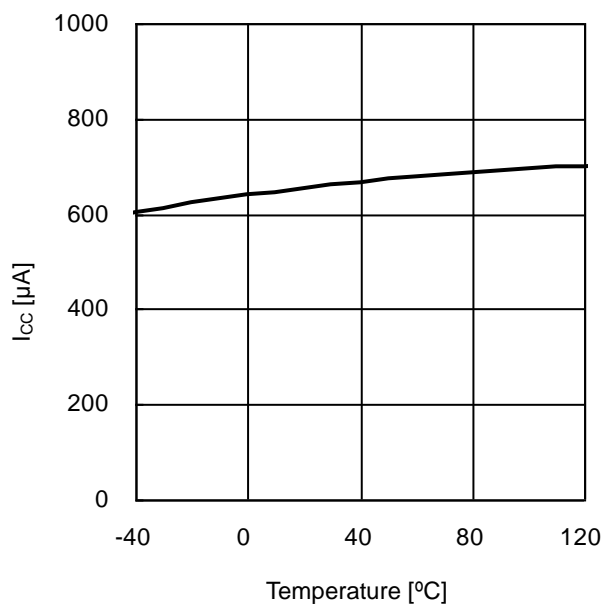

Figure 20. Circuit current I_{CC} vs Temperature

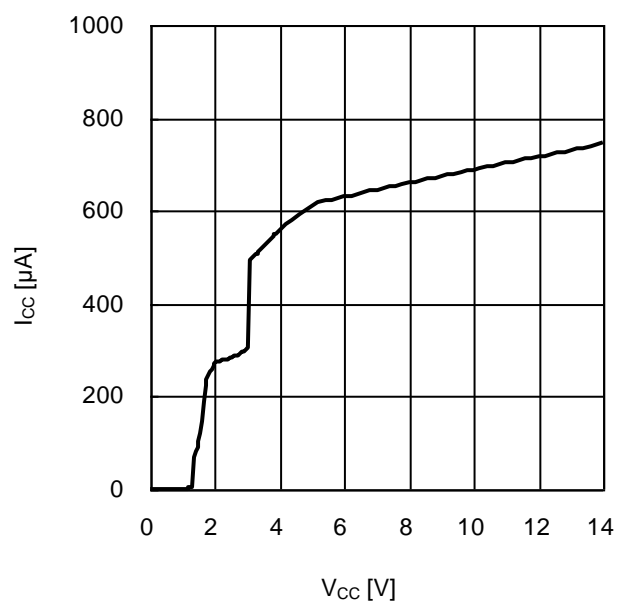

Figure 21. Circuit current I_{CC} vs V_{CC}

Application Information

1. Example of Application 1

Input: 4.5V to 10V, Output: 3.3V / 500mA

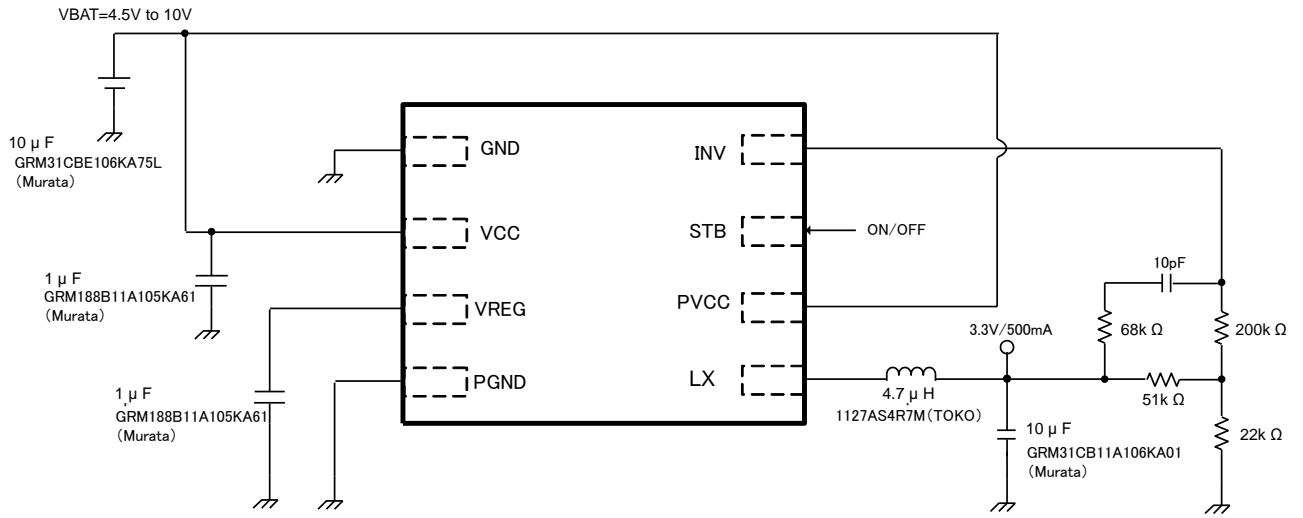

Figure 22. Reference Application Diagram 1

2. Reference Application Data 1 (Example of Application 1)

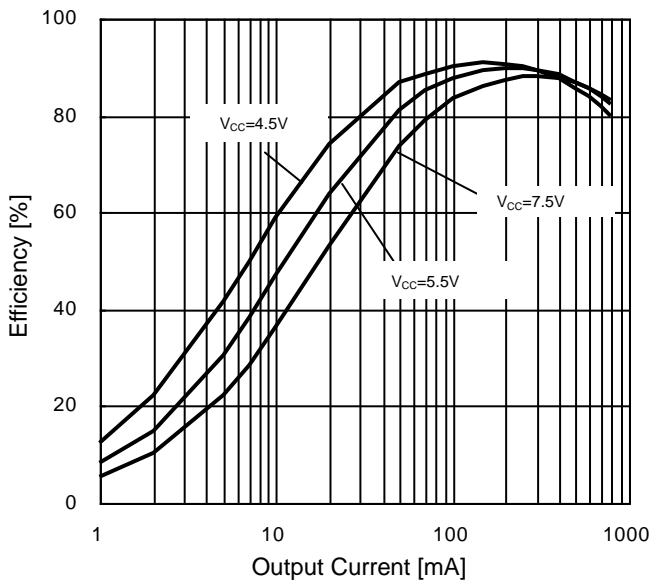

Figure 23. Efficiency vs Output Current (V_{OUT} = 3.3V)

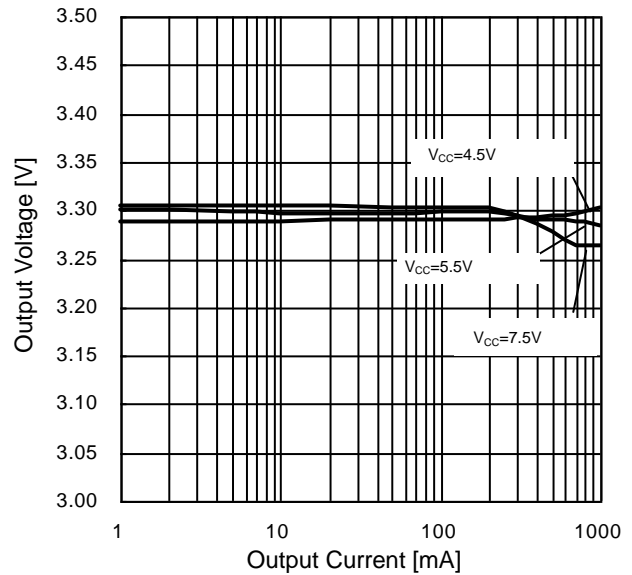

Figure 24. Output Voltage vs Output Current (Load Regulation, V_{OUT} = 3.3V)

3. Reference Application Data 2 (Example of Application 1)

(Input: 4.5V, 6.0V, 8.4V, 10V ; Output: 3.3V)

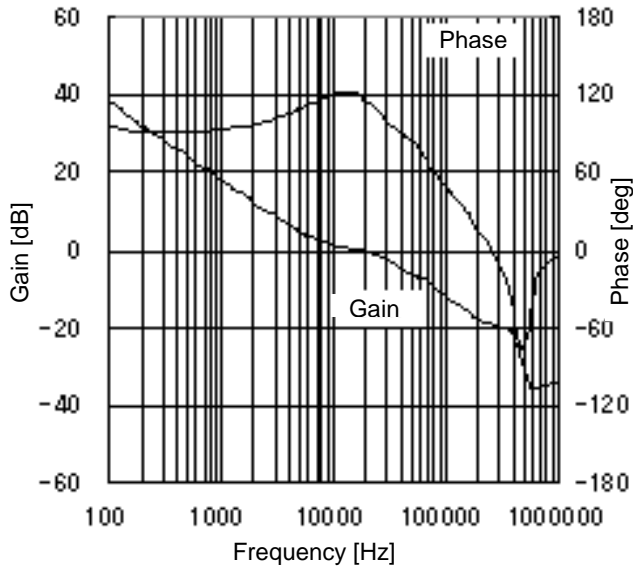

Figure 25. Gain vs Frequency 1
($V_{CC}=4.5V, I_o=250mA$)

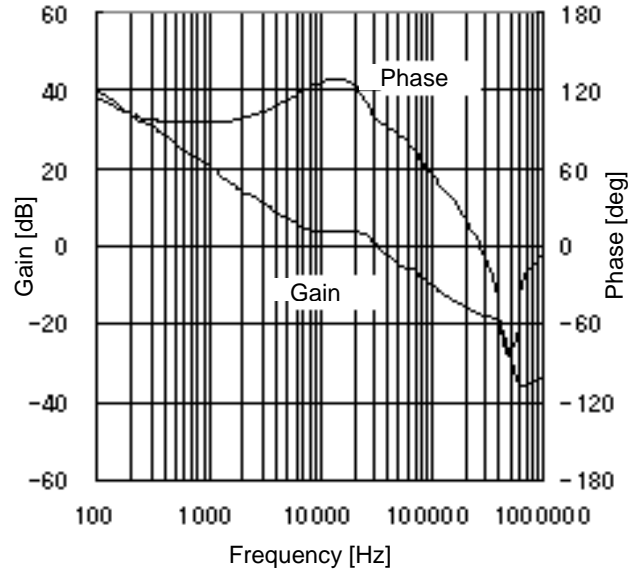

Figure 26 Gain vs Frequency 2
($V_{CC}=6.0V, I_o=250mA$)

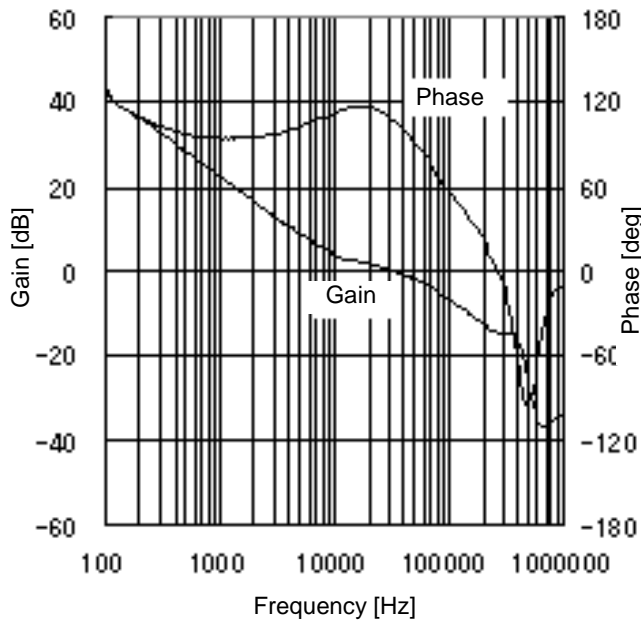

Figure 27. Gain vs Frequency 3
($V_{CC}=8.4V, I_o=250mA$)

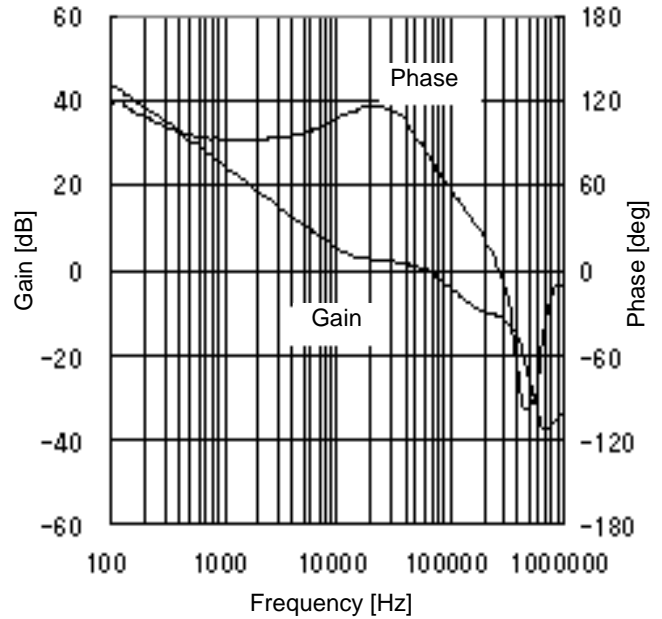

Figure 28. Gain vs Frequency 4
($V_{CC}=10V, I_o=250mA$)

Reference Application Data 2 (Example of Application 1) – continued

(Input: 4.5V, 6.0V, 8.4V, 10V ; Output: 3.3V)

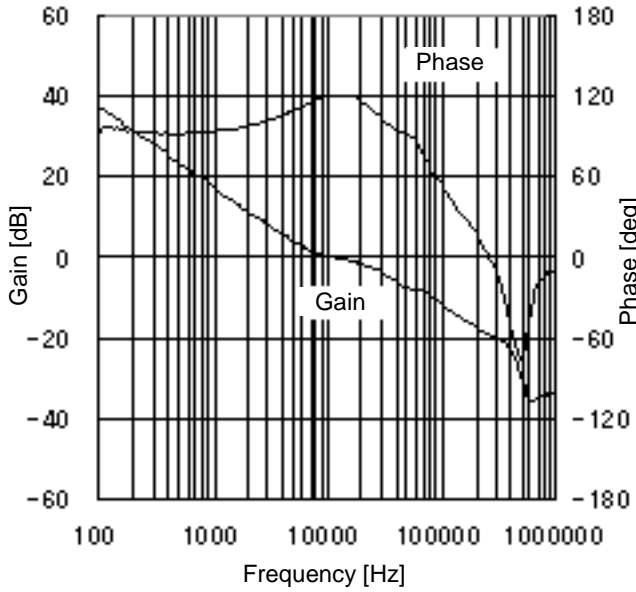

Figure 29. Gain vs Frequency 5
($V_{CC}=4.5V, I_o=500mA$)

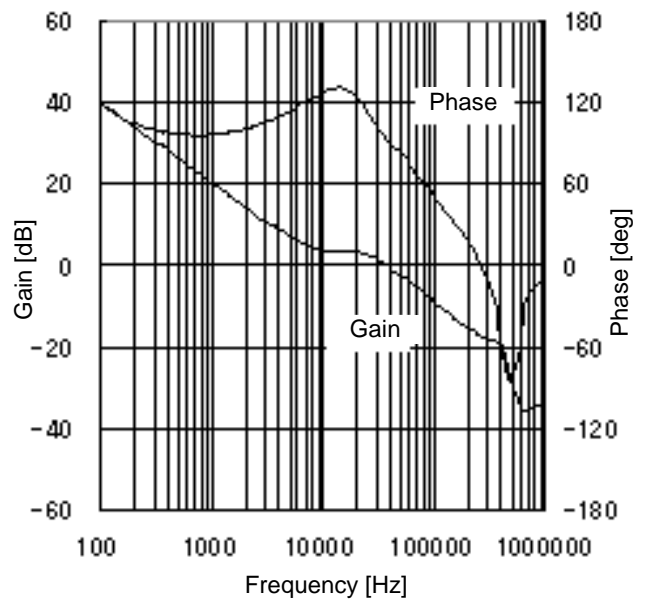

Figure 30. Gain vs Frequency 6
($V_{CC}=6.0V, I_o=500mA$)

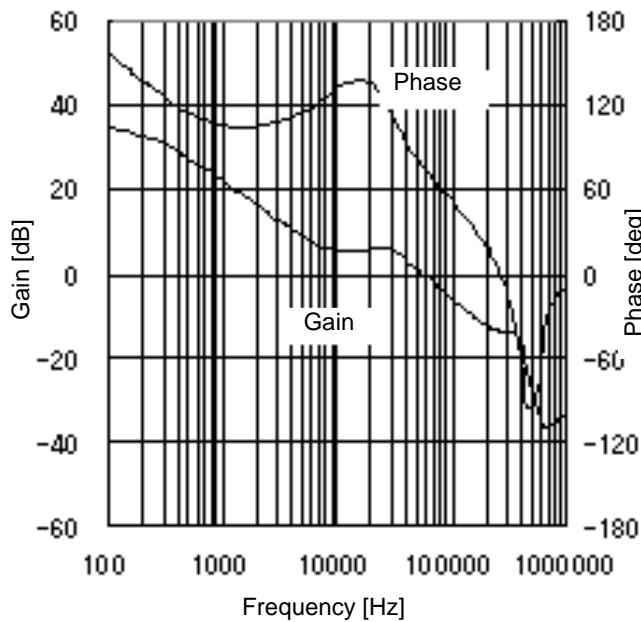

Figure 31. Gain vs Frequency 7
($V_{CC}=8.4V, I_o=500mA$)

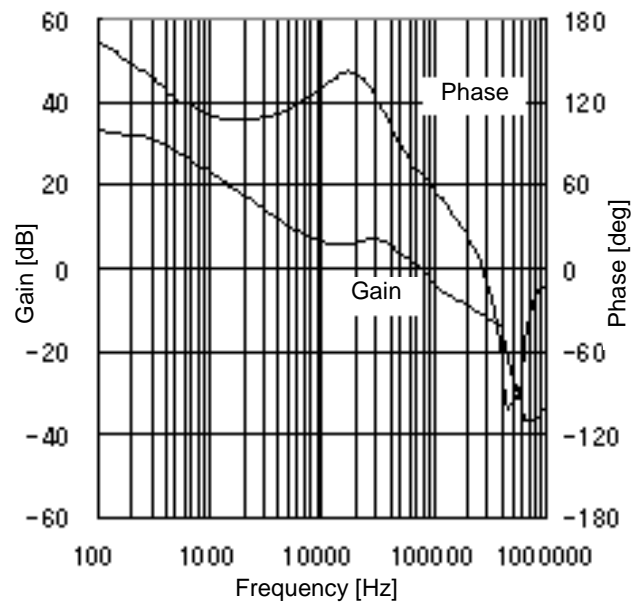

Figure 32. Gain vs Frequency 8
($V_{CC}=10V, I_o=500mA$)

4. Example of Application2

Input: 4.5V to 12V, Output: 1.2V / 500mA

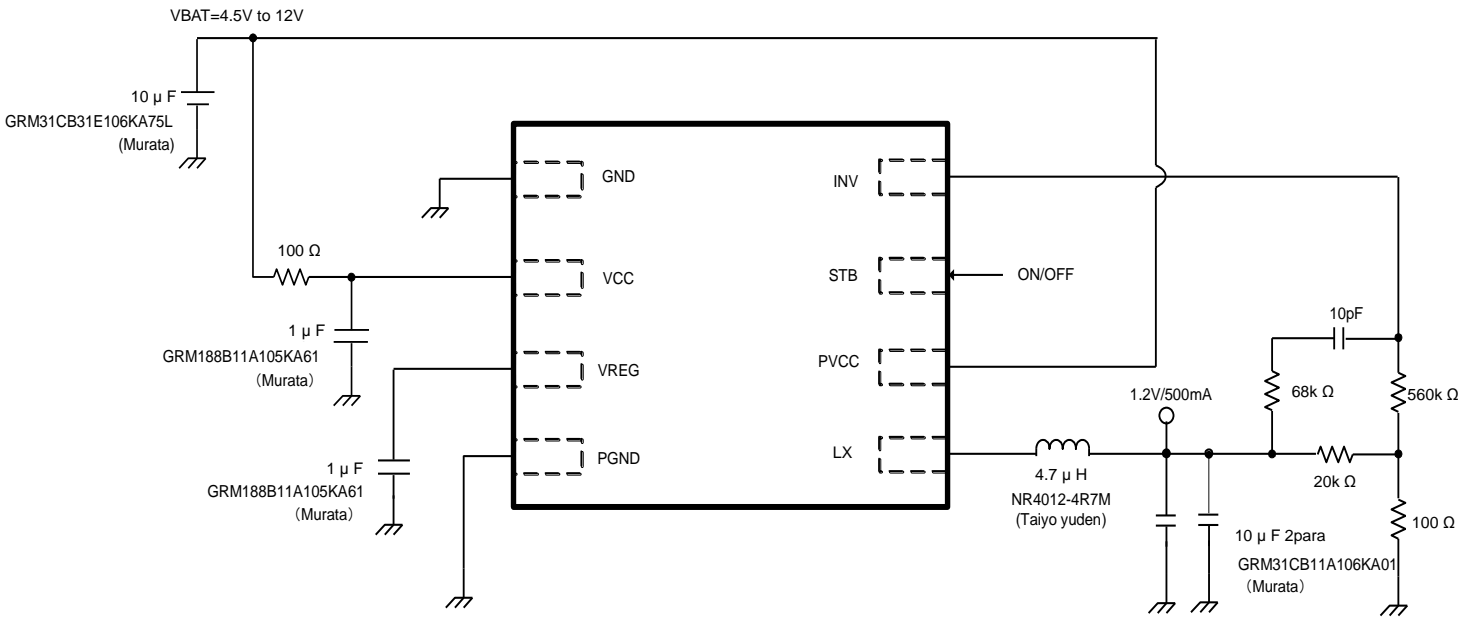

Figure 33. Reference Application Diagram 2

5. Reference Application Data 1 (Example of Application 2)

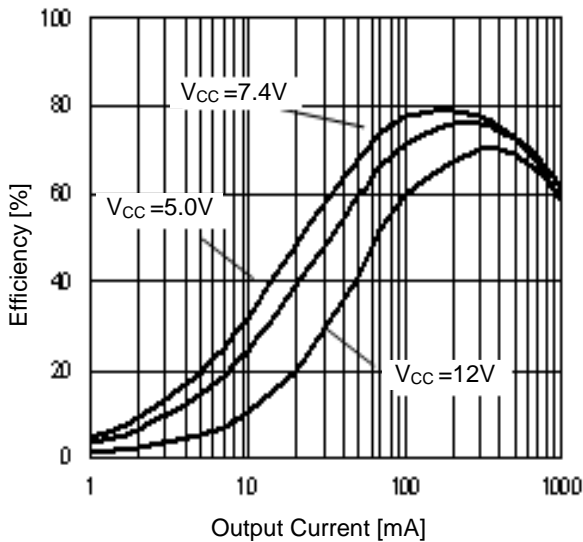

Figure 34. Efficiency vs Output Current (V_{OUT} = 1.2V)

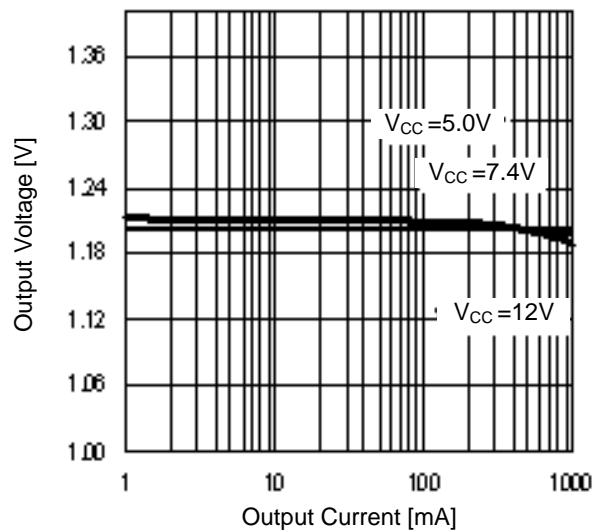

Figure 35. Output Voltage vs Output Current (Load Regulation, V_{OUT} = 1.2V)

6. Reference Application Data 2 (Example of Application 2)

(Input: 5.0V, 7.4V, 10V; Output: 1.2V)

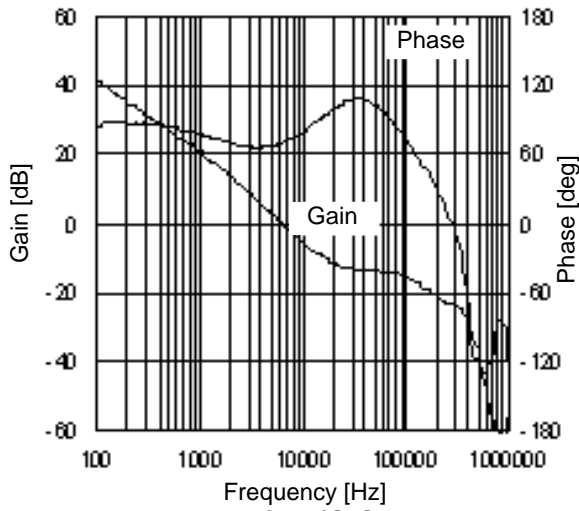

Figure 36. Gain vs Frequency 1
($V_{CC}=5.0V, I_O=100mA$)

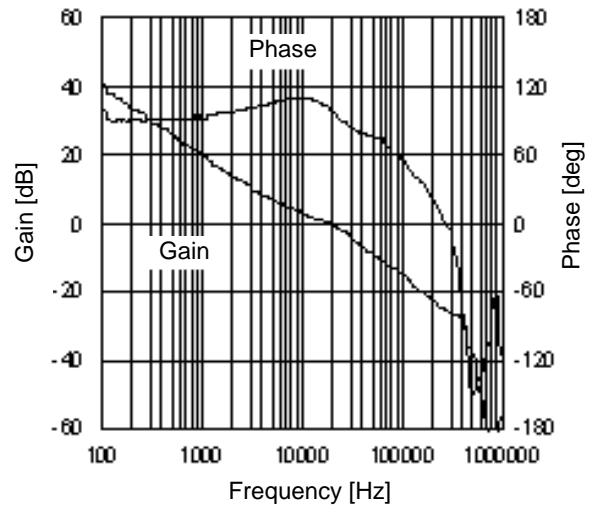

Figure 37. Gain vs Frequency 2
($V_{CC}=5.0V, I_O=300mA$)

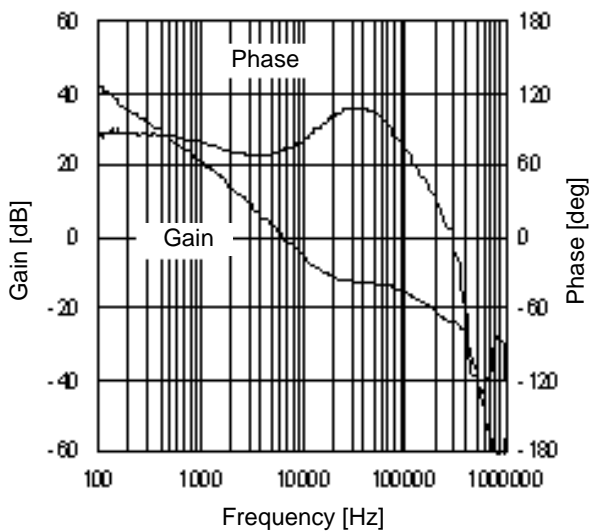

Figure 38. Gain vs Frequency 3
($V_{CC}=5.0V, I_O=900mA$)

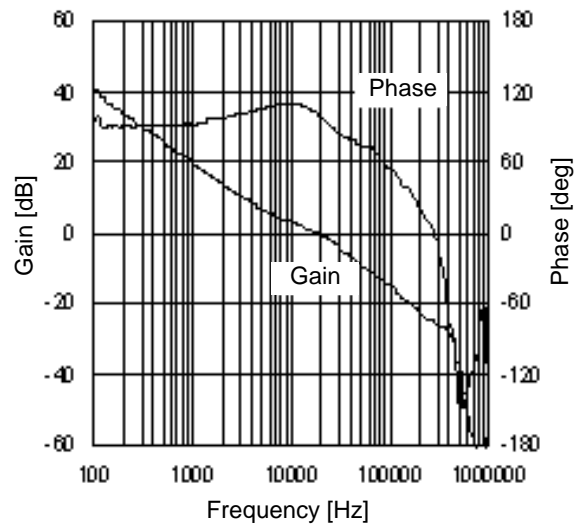

Figure 39. Gain vs Frequency 4
($V_{CC}=7.4V, I_O=100mA$)

Reference Application Data 2 (Example of Application 2) - continued

(Input: 5.0V, 7.4V, 10V; Output: 1.2V)

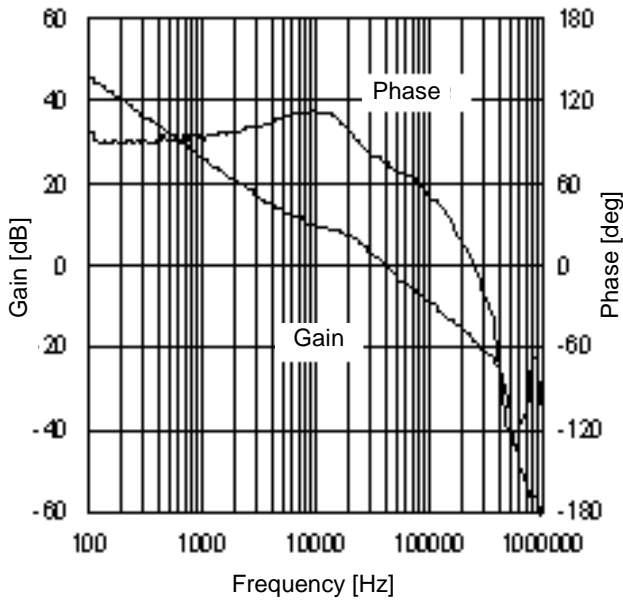

Figure 40. Gain vs Frequency 5
($V_{CC}=7.4V, I_o=300mA$)

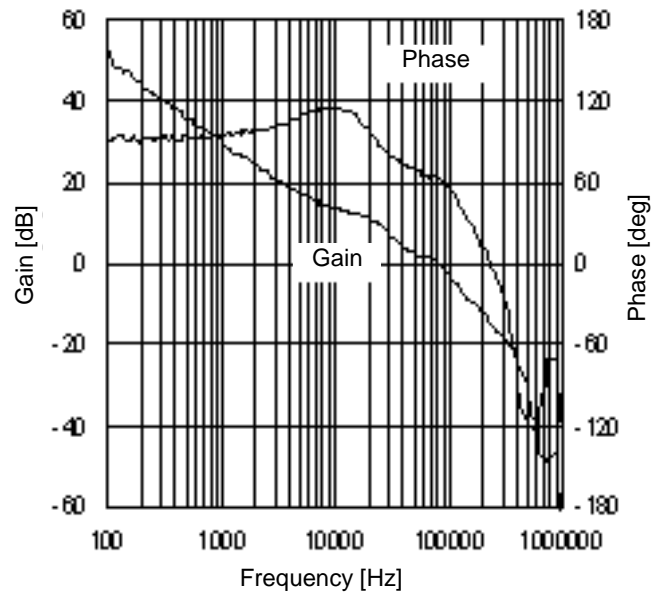

Figure 41. Gain vs Frequency 6
($V_{CC}=7.4V, I_o=900mA$)

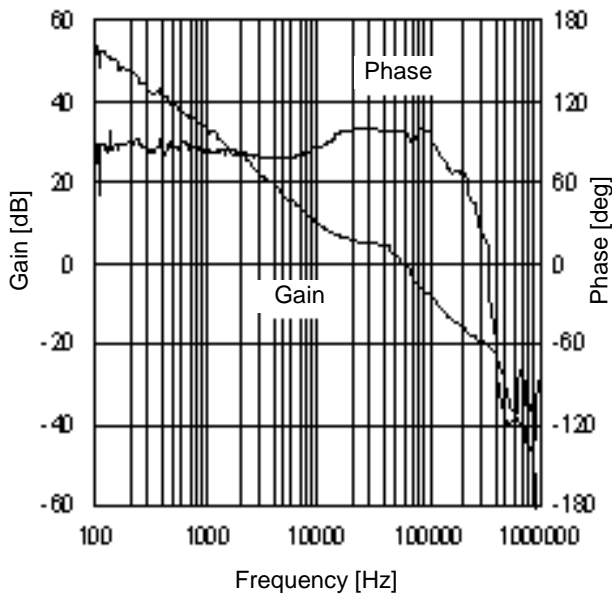

Figure 42. Gain vs Frequency 7
($V_{CC}=10V, I_o=100mA$)

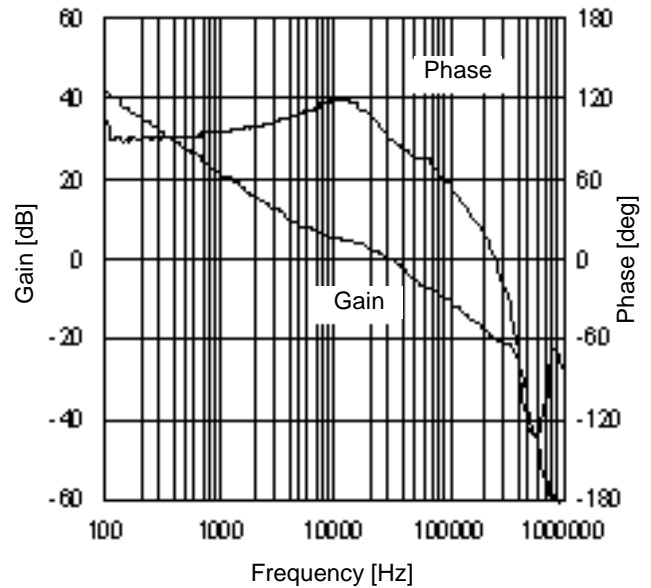

Figure 43. Gain vs Frequency 8
($V_{CC}=10V, I_o=300mA$)

Reference Application Data 2 (Example of Application 2) - continued
 (Input: 5.0V, 7.4V, 10V; Output: 1.2V)

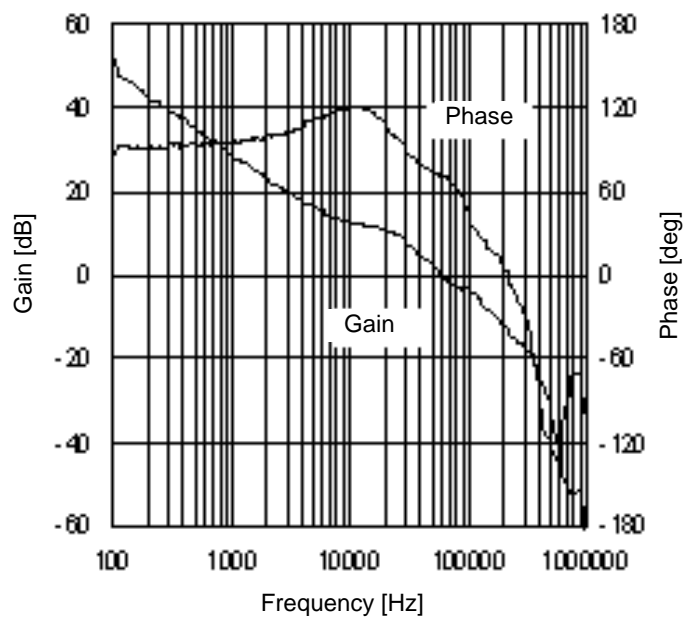

Figure 44. Gain vs Frequency 9
 (V_{CC}=10V, I_O=900mA)

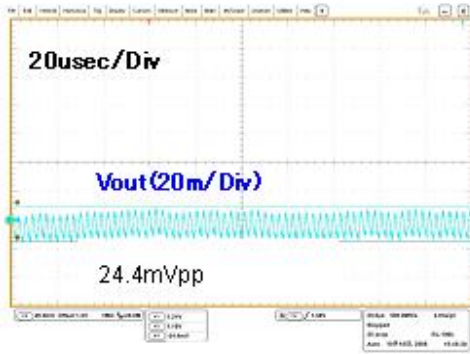

Figure 45. Output Ripple 1
($V_{CC}=12V$, $I_o=40mA$)

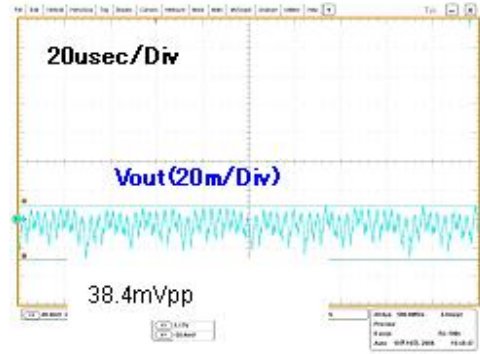

Figure 46. Output Ripple 2
($V_{CC}=12V$, $I_o=100mA$)

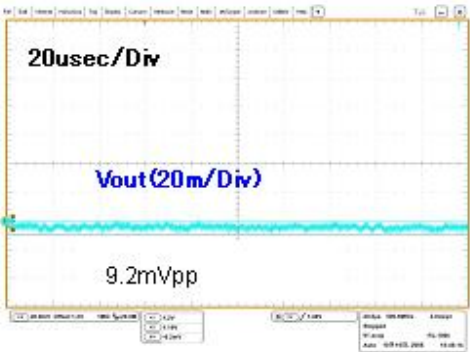

Figure 47. Output Ripple 3
($V_{CC}=12V$, $I_o=140mA$)

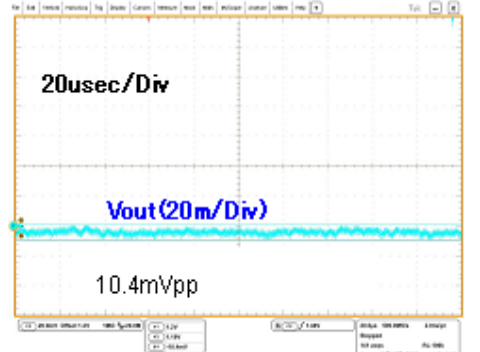

Figure 48. Output Ripple 4
($V_{CC}=12V$, $I_o=170mA$)

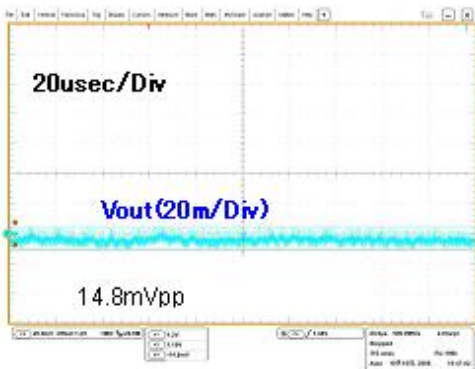
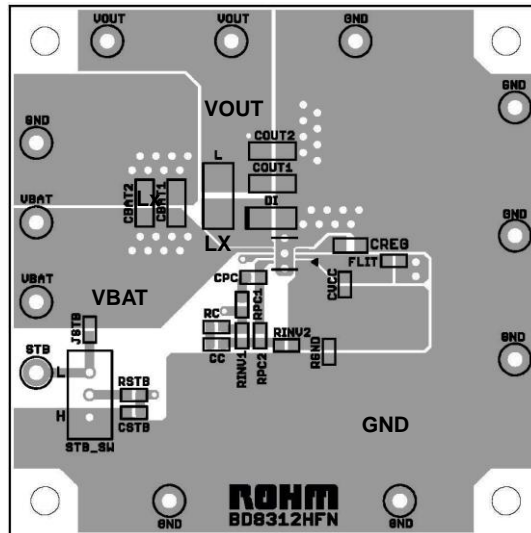

Figure 49. Output Ripple 5
($V_{CC}=12V$, $I_o=900mA$)

7. Reference Board Pattern



- (1) The heat sink at the rear should be a low impedance trace at GND potential and should be at the same potential with the PGND trace.
- (2) It is recommended to install a GND pin not directly connected to the PGND pin, as shown in the picture above.
- (3) Make the patterns for VBAT, LX, and PGND as wide as possible since these paths carry large current.

8. Selection of Parts for Application

(1) Inductor

Select a shielded inductor that satisfies the current rating (I_{peak} as shown in the equation below). Low-DCR (Direct Resistance Component) inductor is also recommended. Inductor values affect inductor ripple current, which will cause output ripple. Ripple current can be reduced by increasing the coil L value or increasing the switching frequency.

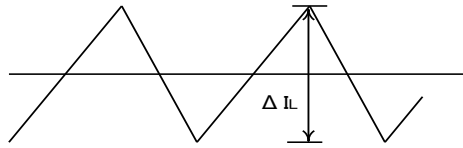

Figure 50. Inductor Current

$$I_{peak} = I_{OUT} + \frac{\Delta I_L}{2} \quad [A] \quad (1)$$

$$\Delta I_L = \frac{V_{IN} - V_{OUT}}{L} \times \frac{V_{OUT}}{V_{IN}} \times \frac{1}{f} \quad [A] \quad (2)$$

where:

η is the Efficiency.

ΔI_L is the Output Ripple Current.

f is the Switching frequency.

As a guide, inductor ripple current should be set at about 20% to 50% of the maximum input current.

Note: Current flowing in the coil that is larger than the coil rating brings the coil into magnetic saturation, which may lead to lower efficiency or output oscillation. Select an inductor with an adequate margin so that the peak current does not exceed the rated current of the coil.

(2) Output capacitor

A ceramic capacitor with low ESR (Equivalent Series Resistance) is recommended for output in order to reduce output ripple. There must be an adequate margin between the maximum rating and output voltage of the capacitor, taking the DC bias property into consideration. Output ripple voltage is obtained through the following equation:

$$V_{pp} = \Delta I_L \times \frac{1}{2\pi \times f \times C_{out}} + \Delta I_L \times R_{ESR} \quad [V] \quad (3)$$

where:

V_{pp} is the Output Ripple Voltage.

C_{out} is the Output Capacitance .

R_{ESR} is the Equivalent Series Resistance.

Setting must be performed so that output ripple is within the allowable ripple voltage.

(3) Output Voltage Setting

The internal reference voltage of the ERROR AMP is 1.0V. Output voltage is acquired by Equation (4).

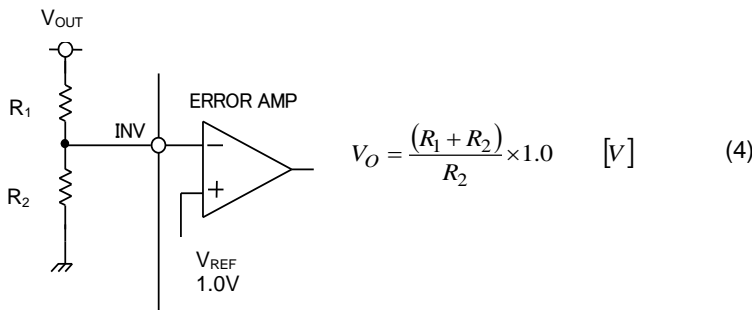

Figure 51. Setting of Voltage Feedback Resistance

(4) DC/DC converter frequency response adjustment system

Condition for stable application

The condition for feedback system stability under negative feedback is that the phase delay is 135° or less when gain is 1 (0dB). Since DC/DC converter application is sampled according to the switching frequency, the bandwidth G_{BW} of the whole system (frequency at which gain is 0 dB) must be controlled to be equal to or lower than 1/10 of the switching frequency. In summary, the conditions necessary for the DC/DC converter are:

- Phase delay must be 135° or lower when gain is 1 (0 dB).
- Bandwidth G_{BW} (frequency when gain is 0 dB) must be equal to or lower than 1/10 of the switching frequency.

To satisfy those two conditions, R_1 , R_2 , R_3 , C_s and R_s in Figure 53 should be set as follows.

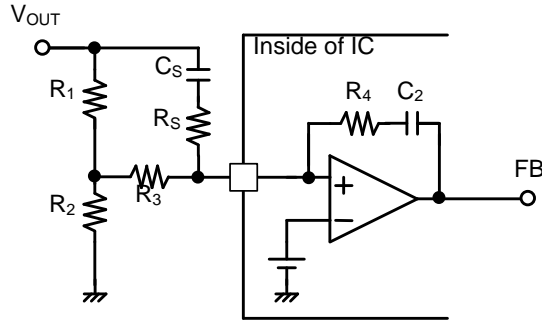

Figure 52. Example of Phase Compensation Setting

(a) Setting R_1 , R_2 , R_3

BD8313HFN incorporates phase compensation devices of $R_4=62k\Omega$ and $C_2=200pF$. These C_2 and R_1 , R_2 , and R_3 values decide the primary pole that determines the bandwidth of DC/DC Converter primary pole point frequency.

$$f_p = \frac{1}{2\pi \left[A \times C_2 \times \left(\frac{R_1 \times R_2}{R_1 + R_2} + R_3 \right) \right]} \tag{5}$$

DC/DC converter DC Gain

$$DCGain = A \times \left(\frac{1}{B} \right) \times \left(\frac{V_{IN}}{V_O} \right) \tag{6}$$

where:

A is the Error AMP Gain (100dB = 10^5).

B is the Oscillator amplification (typically 0.5V).

V_{IN} is the Input voltage.

V_{OUT} is the Output voltage.

Using Equations (5) and (6), the frequency f_{sw} of point 0 dB under limitation of the bandwidth of the DC gain at the primary pole point is as shown below.

$$f_{sw} = f_p \times DCGain = \frac{1}{2\pi C_2 \times \left[\frac{R_1 \times R_2}{R_1 + R_2} + R_3 \right]} \times \left(\frac{1}{B} \right) \times \left(\frac{V_{IN}}{V_O} \right) \tag{7}$$

It is recommended that f_{sw} should be approximately 10 kHz. When load response is difficult, it may be set at approximately 20 kHz. In Equation (7), R_1 and R_2 , which determine the voltage value, will be in the order of several hundred k Ω . If an appropriate resistance value is not available since the resistance is so high and routing may cause noise, the use of R_3 enables easy setting.

(b) Setting C_s and R_s

For DC/DC converter, the second dimension pole point is caused by the coil and capacitor as expressed by the following equation.

$$f_{LC} = \frac{1}{2\pi\sqrt{LCout}} \quad (8)$$

This secondary pole causes a phase rotation of 180°. To secure the stability of the system, put a zero point in 2 places to perform compensation.

Zero point by built-in CR $f_{z1} = \frac{1}{2\pi R_4 C_2} = 13kHz \dots (9)$

Zero point by C_s $f_{z2} = \frac{1}{2\pi(R_1 + R_3)C_s} \dots (10)$

Setting f_{z2} to be half to two times the frequency as large as f_{LC} provides an appropriate phase margin. It is desirable to set R_s at about 1/20 of (R_1+R_3) to cancel any phase boosting at high frequencies. Those pole points are summarized in the figure below. The actual frequency property is different from the ideal calculation because of part constants. If possible, check the phase margin with a frequency analyzer or network analyzer. Otherwise, check for the presence or absence of ringing by load response waveform and also check for the presence or absence of oscillation under a load of an adequate margin.

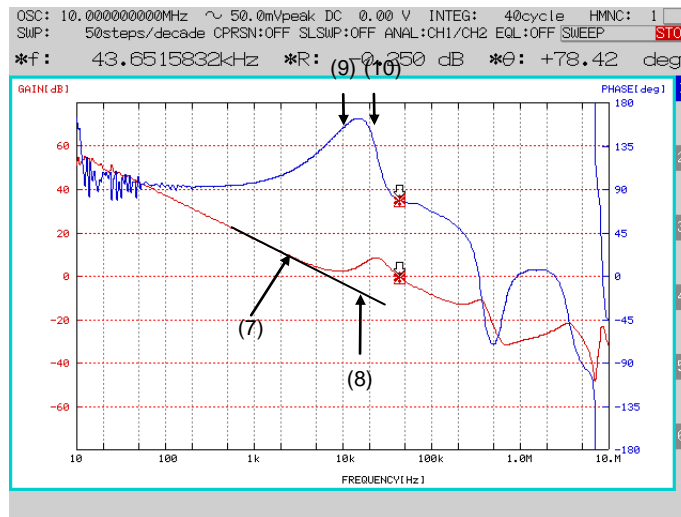
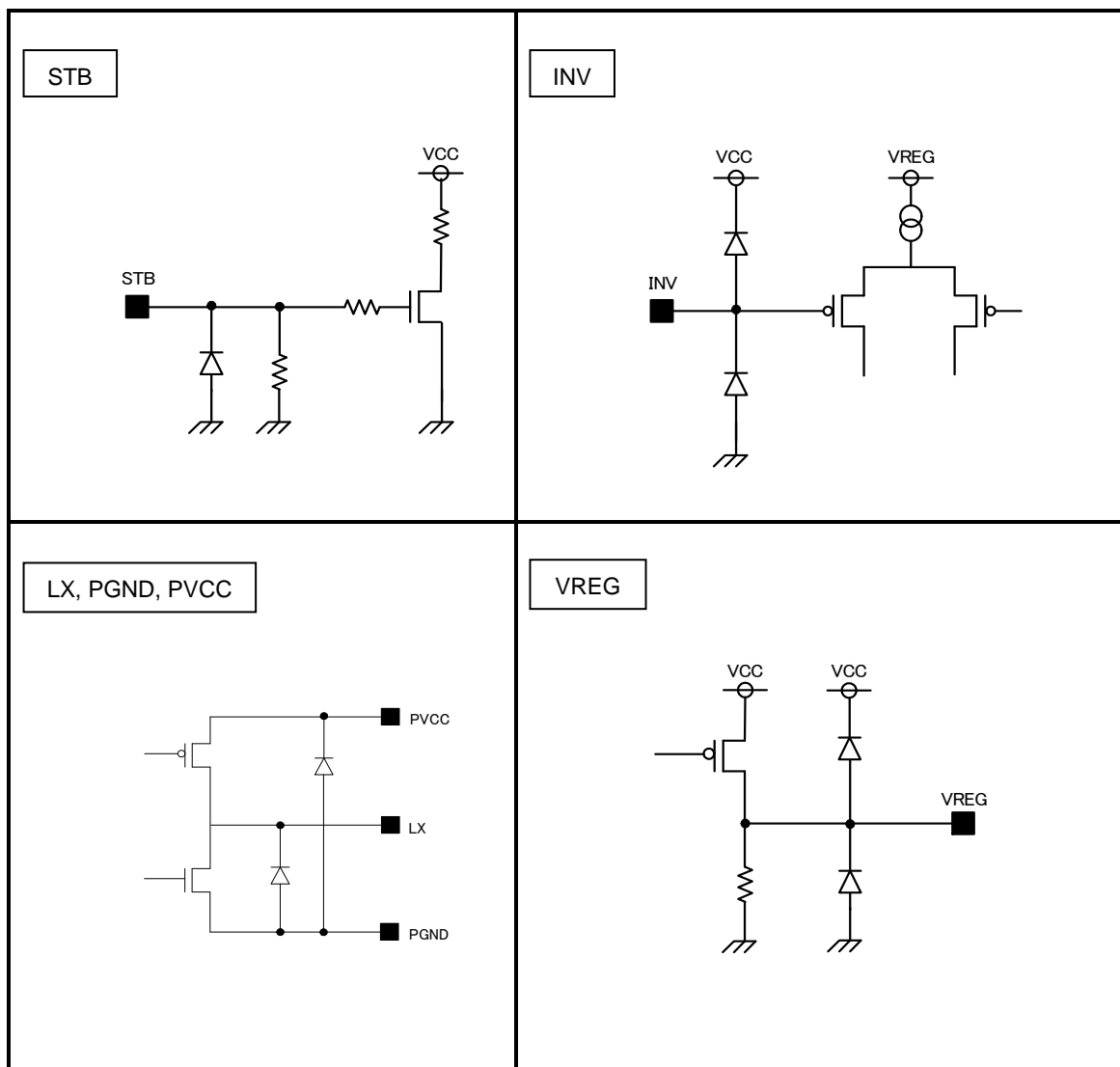

Figure 53 . Example of DC/DC Converter Frequency Property (Measured with FRA5097 by NF Corporation)

I/O Equivalent Circuit



Operational Notes

1. Reverse Connection of Power Supply

Connecting the power supply in reverse polarity can damage the IC. Take precautions against reverse polarity when connecting the power supply, such as mounting an external diode between the power supply and the IC's power supply pins.

2. Power Supply Lines

Design the PCB layout pattern to provide low impedance supply lines. Separate the ground and supply lines of the digital and analog blocks to prevent noise in the ground and supply lines of the digital block from affecting the analog block. Furthermore, connect a capacitor to ground at all power supply pins. Consider the effect of temperature and aging on the capacitance value when using electrolytic capacitors.

3. Ground Voltage

Ensure that no pins are at a voltage below that of the ground pin at any time, even during transient condition.

4. Ground Wiring Pattern

When using both small-signal and large-current ground traces, the two ground traces should be routed separately but connected to a single ground at the reference point of the application board to avoid fluctuations in the small-signal ground caused by large currents. Also ensure that the ground traces of external components do not cause variations on the ground voltage. The ground lines must be as short and thick as possible to reduce line impedance.

5. Thermal Consideration

Should by any chance the power dissipation rating be exceeded the rise in temperature of the chip may result in deterioration of the properties of the chip. In case of exceeding this absolute maximum rating, increase the board size and copper area to prevent exceeding the Pd rating.

6. Recommended Operating Conditions

These conditions represent a range within which the expected characteristics of the IC can be approximately obtained. The electrical characteristics are guaranteed under the conditions of each parameter.

7. Inrush Current

When power is first supplied to the IC, it is possible that the internal logic may be unstable and inrush current may flow instantaneously due to the internal powering sequence and delays, especially if the IC has more than one power supply. Therefore, give special consideration to power coupling capacitance, power wiring, width of ground wiring, and routing of connections.

8. Operation Under Strong Electromagnetic Field

Operating the IC in the presence of a strong electromagnetic field may cause the IC to malfunction.

9. Testing on Application Boards

When testing the IC on an application board, connecting a capacitor directly to a low-impedance output pin may subject the IC to stress. Always discharge capacitors completely after each process or step. The IC's power supply should always be turned off completely before connecting or removing it from the test setup during the inspection process. To prevent damage from static discharge, ground the IC during assembly and use similar precautions during transport and storage.

10. Inter-pin Short and Mounting Errors

Ensure that the direction and position are correct when mounting the IC on the PCB. Incorrect mounting may result in damaging the IC. Avoid nearby pins being shorted to each other especially to ground, power supply and output pin. Inter-pin shorts could be due to many reasons such as metal particles, water droplets (in very humid environment) and unintentional solder bridge deposited in between pins during assembly to name a few.

Operational Notes – continued

11. **Unused Input Pins**

Input pins of an IC are often connected to the gate of a MOS transistor. The gate has extremely high impedance and extremely low capacitance. If left unconnected, the electric field from the outside can easily charge it. The small charge acquired in this way is enough to produce a significant effect on the conduction through the transistor and cause unexpected operation of the IC. So unless otherwise specified, unused input pins should be connected to the power supply or ground line.

12. **Regarding the Input Pin of the IC**

This monolithic IC contains P+ isolation and P substrate layers between adjacent elements in order to keep them isolated. P-N junctions are formed at the intersection of the P layers with the N layers of other elements, creating a parasitic diode or transistor. For example (refer to figure below):

When GND > Pin A and GND > Pin B, the P-N junction operates as a parasitic diode.
 When GND > Pin B, the P-N junction operates as a parasitic transistor.

Parasitic diodes inevitably occur in the structure of the IC. The operation of parasitic diodes can result in mutual interference among circuits, operational faults, or physical damage. Therefore, conditions that cause these diodes to operate, such as applying a voltage lower than the GND voltage to an input pin (and thus to the P substrate) should be avoided.

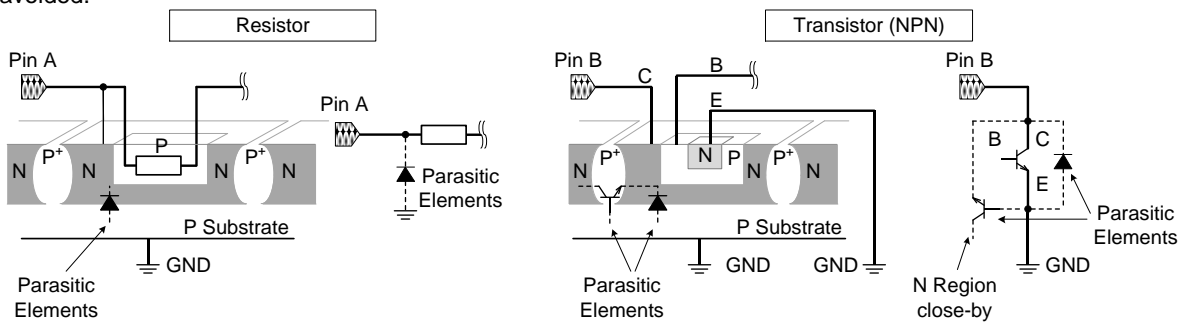

Figure 55. Example of monolithic IC structure

13. **Thermal Shutdown Circuit(TSD)**

This IC has a built-in thermal shutdown circuit that prevents heat damage to the IC. Normal operation should always be within the IC's power dissipation rating. If however the rating is exceeded for a continued period, the junction temperature (T_j) will rise which will activate the TSD circuit that will turn OFF all output pins. When the T_j falls below the TSD threshold, the circuits are automatically restored to normal operation.

Note that the TSD circuit operates in a situation that exceeds the absolute maximum ratings and therefore, under no circumstances, should the TSD circuit be used in a set design or for any purpose other than protecting the IC from heat damage.

Ordering Information

BD8313HFN - TR

Part Number

Package
HFN: HSON8

Packaging and forming specification
TR: Embossed tape and reel

Marking Diagram

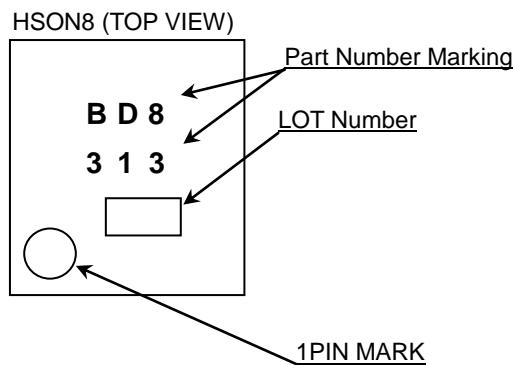

Physical Dimension, Tape and Reel information

Package Name	HSO8
--------------	------

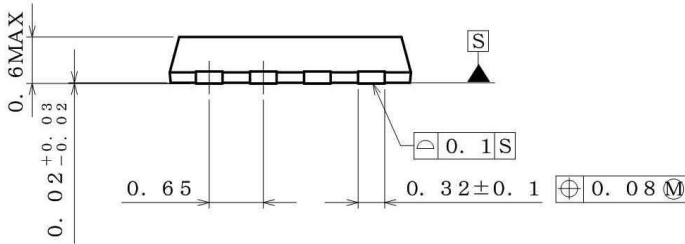
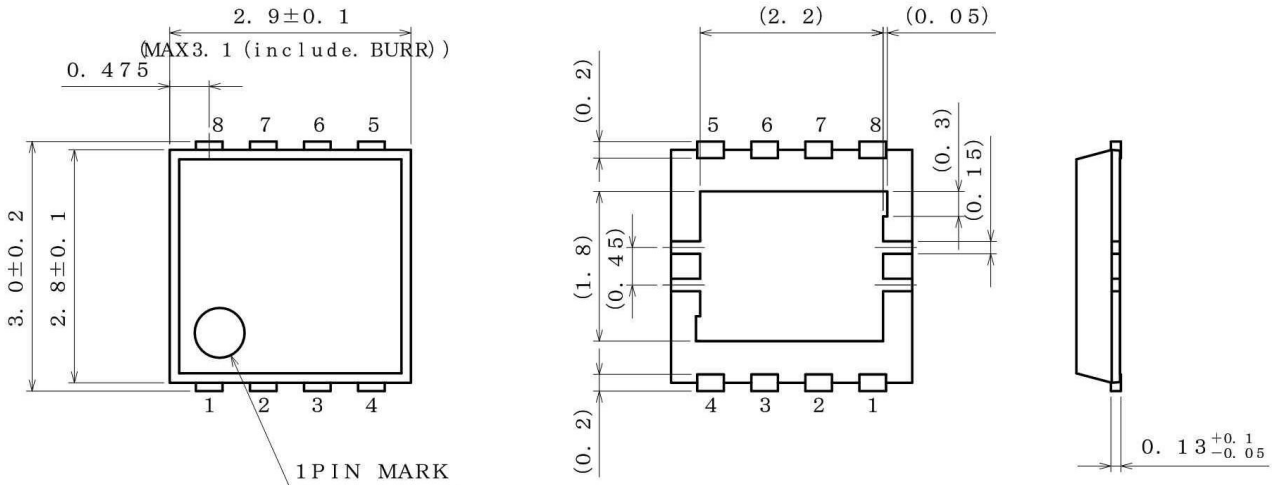

(UNIT : mm)
 PKG : HSO8
 Drawing No. EX163-5002

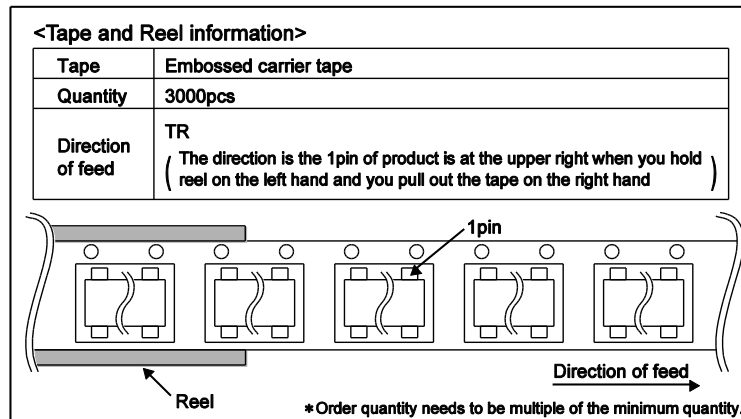

Revision History

Date	Revision	Changes
26.Nov.2014	001	New Release
18.Feb.2015	002	Correction of the writing.

Notice

Precaution on using ROHM Products

- Our Products are designed and manufactured for application in ordinary electronic equipments (such as AV equipment, OA equipment, telecommunication equipment, home electronic appliances, amusement equipment, etc.). If you intend to use our Products in devices requiring extremely high reliability (such as medical equipment ^(Note 1), transport equipment, traffic equipment, aircraft/spacecraft, nuclear power controllers, fuel controllers, car equipment including car accessories, safety devices, etc.) and whose malfunction or failure may cause loss of human life, bodily injury or serious damage to property ("Specific Applications"), please consult with the ROHM sales representative in advance. Unless otherwise agreed in writing by ROHM in advance, ROHM shall not be in any way responsible or liable for any damages, expenses or losses incurred by you or third parties arising from the use of any ROHM's Products for Specific Applications.

(Note1) Medical Equipment Classification of the Specific Applications

JAPAN	USA	EU	CHINA
CLASS III	CLASS III	CLASS II b	CLASS III
CLASS IV		CLASS III	

- ROHM designs and manufactures its Products subject to strict quality control system. However, semiconductor products can fail or malfunction at a certain rate. Please be sure to implement, at your own responsibilities, adequate safety measures including but not limited to fail-safe design against the physical injury, damage to any property, which a failure or malfunction of our Products may cause. The following are examples of safety measures:
 - Installation of protection circuits or other protective devices to improve system safety
 - Installation of redundant circuits to reduce the impact of single or multiple circuit failure
- Our Products are designed and manufactured for use under standard conditions and not under any special or extraordinary environments or conditions, as exemplified below. Accordingly, ROHM shall not be in any way responsible or liable for any damages, expenses or losses arising from the use of any ROHM's Products under any special or extraordinary environments or conditions. If you intend to use our Products under any special or extraordinary environments or conditions (as exemplified below), your independent verification and confirmation of product performance, reliability, etc. prior to use, must be necessary:
 - Use of our Products in any types of liquid, including water, oils, chemicals, and organic solvents
 - Use of our Products outdoors or in places where the Products are exposed to direct sunlight or dust
 - Use of our Products in places where the Products are exposed to sea wind or corrosive gases, including Cl₂, H₂S, NH₃, SO₂, and NO₂
 - Use of our Products in places where the Products are exposed to static electricity or electromagnetic waves
 - Use of our Products in proximity to heat-producing components, plastic cords, or other flammable items
 - Sealing or coating our Products with resin or other coating materials
 - Use of our Products without cleaning residue of flux (even if you use no-clean type fluxes, cleaning residue of flux is recommended); or Washing our Products by using water or water-soluble cleaning agents for cleaning residue after soldering
 - Use of the Products in places subject to dew condensation
- The Products are not subject to radiation-proof design.
- Please verify and confirm characteristics of the final or mounted products in using the Products.
- In particular, if a transient load (a large amount of load applied in a short period of time, such as pulse. is applied, confirmation of performance characteristics after on-board mounting is strongly recommended. Avoid applying power exceeding normal rated power; exceeding the power rating under steady-state loading condition may negatively affect product performance and reliability.
- De-rate Power Dissipation (Pd) depending on Ambient temperature (Ta). When used in sealed area, confirm the actual ambient temperature.
- Confirm that operation temperature is within the specified range described in the product specification.
- ROHM shall not be in any way responsible or liable for failure induced under deviant condition from what is defined in this document.

Precaution for Mounting / Circuit board design

- When a highly active halogenous (chlorine, bromine, etc.) flux is used, the residue of flux may negatively affect product performance and reliability.
- In principle, the reflow soldering method must be used on a surface-mount products, the flow soldering method must be used on a through hole mount products. If the flow soldering method is preferred on a surface-mount products, please consult with the ROHM representative in advance.

For details, please refer to ROHM Mounting specification

Precautions Regarding Application Examples and External Circuits

1. If change is made to the constant of an external circuit, please allow a sufficient margin considering variations of the characteristics of the Products and external components, including transient characteristics, as well as static characteristics.
2. You agree that application notes, reference designs, and associated data and information contained in this document are presented only as guidance for Products use. Therefore, in case you use such information, you are solely responsible for it and you must exercise your own independent verification and judgment in the use of such information contained in this document. ROHM shall not be in any way responsible or liable for any damages, expenses or losses incurred by you or third parties arising from the use of such information.

Precaution for Electrostatic

This Product is electrostatic sensitive product, which may be damaged due to electrostatic discharge. Please take proper caution in your manufacturing process and storage so that voltage exceeding the Products maximum rating will not be applied to Products. Please take special care under dry condition (e.g. Grounding of human body / equipment / solder iron, isolation from charged objects, setting of Ionizer, friction prevention and temperature / humidity control).

Precaution for Storage / Transportation

1. Product performance and soldered connections may deteriorate if the Products are stored in the places where:
 - [a] the Products are exposed to sea winds or corrosive gases, including Cl₂, H₂S, NH₃, SO₂, and NO₂
 - [b] the temperature or humidity exceeds those recommended by ROHM
 - [c] the Products are exposed to direct sunshine or condensation
 - [d] the Products are exposed to high Electrostatic
2. Even under ROHM recommended storage condition, solderability of products out of recommended storage time period may be degraded. It is strongly recommended to confirm solderability before using Products of which storage time is exceeding the recommended storage time period.
3. Store / transport cartons in the correct direction, which is indicated on a carton with a symbol. Otherwise bent leads may occur due to excessive stress applied when dropping of a carton.
4. Use Products within the specified time after opening a humidity barrier bag. Baking is required before using Products of which storage time is exceeding the recommended storage time period.

Precaution for Product Label

QR code printed on ROHM Products label is for ROHM's internal use only.

Precaution for Disposition

When disposing Products please dispose them properly using an authorized industry waste company.

Precaution for Foreign Exchange and Foreign Trade act

Since our Products might fall under controlled goods prescribed by the applicable foreign exchange and foreign trade act, please consult with ROHM representative in case of export.

Precaution Regarding Intellectual Property Rights

1. All information and data including but not limited to application example contained in this document is for reference only. ROHM does not warrant that foregoing information or data will not infringe any intellectual property rights or any other rights of any third party regarding such information or data. ROHM shall not be in any way responsible or liable for infringement of any intellectual property rights or other damages arising from use of such information or data.:
2. No license, expressly or implied, is granted hereby under any intellectual property rights or other rights of ROHM or any third parties with respect to the information contained in this document.

Other Precaution

1. This document may not be reprinted or reproduced, in whole or in part, without prior written consent of ROHM.
2. The Products may not be disassembled, converted, modified, reproduced or otherwise changed without prior written consent of ROHM.
3. In no event shall you use in any way whatsoever the Products and the related technical information contained in the Products or this document for any military purposes, including but not limited to, the development of mass-destruction weapons.
4. The proper names of companies or products described in this document are trademarks or registered trademarks of ROHM, its affiliated companies or third parties.

General Precaution

1. Before you use our Products, you are requested to carefully read this document and fully understand its contents. ROHM shall not be in any way responsible or liable for failure, malfunction or accident arising from the use of any ROHM's Products against warning, caution or note contained in this document.
2. All information contained in this document is current as of the issuing date and subject to change without any prior notice. Before purchasing or using ROHM's Products, please confirm the latest information with a ROHM sales representative.
3. The information contained in this document is provided on an "as is" basis and ROHM does not warrant that all information contained in this document is accurate and/or error-free. ROHM shall not be in any way responsible or liable for any damages, expenses or losses incurred by you or third parties resulting from inaccuracy or errors of or concerning such information.