

## Single Channel Silicon ESD Protector Overvoltage Protection Device

PRODUCT: SESD0402X1UN-0020-090

DOCUMENT: SCD28186  
REV LETTER: A  
REV DATE: December 6, 2011  
PAGE NO.: Page 1 of 6

### Specification Status: Preliminary

#### BENEFITS

- Industry-leading lowest capacitance; provides lowest insertion loss for high speed data signals
- Small size ESD protection diodes for high speed data signals (0402 size devices)
- Helps protect electronic circuits against damage from Electrostatic Discharge (ESD), surge and cable discharge events
- Assists equipment to pass IEC61000-4-2, level 4 testing

#### FEATURES

- Low capacitance: 0.20 pF (typ, uni-di)
- Low leakage current : 50nA @ 5V (max)
- Low clamping voltage: +9.18 / -0.8V (typ, uni-di) @ (tp=8x20µs, Ipp=2A)
- ESD maximum rating per IEC61000-4-2 standard:
  - ± 20kV contact discharge
  - ± 20kV air discharge
- Surge: 2A (max, uni-di) @ (tp=8x20µs) per IEC61000-4-2-5
- Small size and low profile: XDFN packages



#### PART NUMBERING

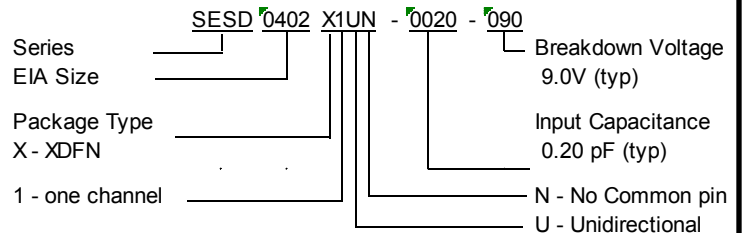

#### APPLICATIONS

- Consumer, mobile and portable electronics
- Tablet PC and external storage with high speed interfaces
- Ultra-high speed data lines
- USB 3.0/2.0, HDMI 1.3/1.4, DisplayPort, Thunderbolt (Light Peak), V-by-One HS, and LVDS interfaces
- Applications requiring high ESD performance in small packages

#### SCHEMATIC AND PIN CONFIGURATION

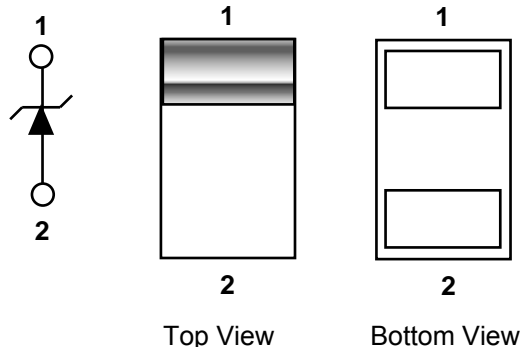

#### MATERIALS INFORMATION

RoHS Compliant ELV Compliant Halogen Free \* Lead Free

Directive 2000/53/EC  
Compliant

Directive 2002/95/EC  
Compliant



\* Halogen Free refers to: Br≤900ppm, Cl≤900ppm, Br+Cl≤1500ppm

SESD devices meet MSL-1 Requirements

DFN case epoxy meets UL 94 V-0

# Single Channel Silicon ESD Protector Overvoltage Protection Device

## DEVICE MAXIMUM RATING

ESD Withstand <sup>(1)</sup> (IEC 61000-4-2, level 4)		Temperature		Peak Current (tp=8x20µs)
Contact (kV)	Air (kV)	Operating (°C)	Storage (°C)	Ipp (A)
± 20	± 20	-55 to +125	-55 to +150	2.0

<sup>(1)</sup> 20kV @ ± 1 pulse; 10kV @ ± 50 pulses; 8kV @ 1,000 pulses (under IEC6100-4-2)

- Device maximum rating @ T = 25°C, unless otherwise specified
- Caution: Stress exceeding Device Maximum Ratings may damage the device  
Prolonged exposure to stresses above the recommended operating conditions may affect device reliability

## DEVICE ELECTRICAL CHARACTERISTICS

Input Capacitance @ V <sub>R</sub> = 0V, f = 3GHz (pF)		Breakdown Voltage V <sub>BR</sub> @ I <sub>T</sub> =1mA (V)	Reverse Working Voltage (V)		Reverse Leakage Current I <sub>L</sub> @ V <sub>WRV</sub> =5.0V (nA)		Clamping Voltage V <sub>CL</sub> @ Ipp=2.0A (V)
Typ	Maximum	Typ	Min	Max	Typ	Max	Max
0.20	0.22	+9.00 / -0.80	0	+8.00	<5.0	50.0	+9.18 / -0.80

- All device electrical characteristics @ T = 25°C, unless otherwise specified

## FIGURE 1. INSERTION LOSS DIAGRAM

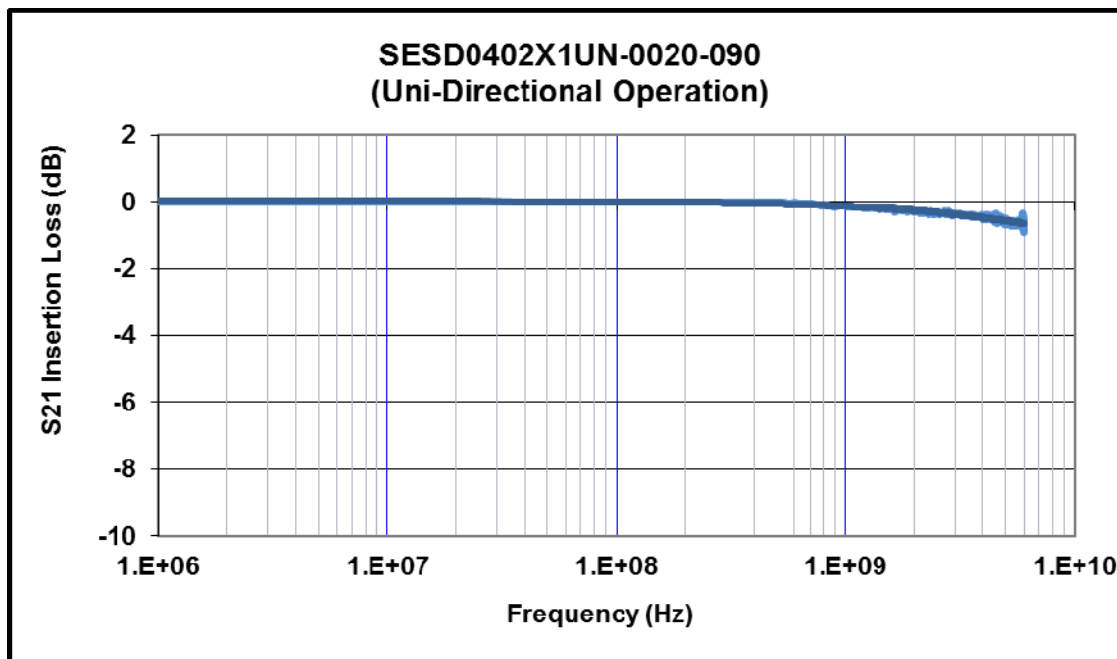

Application	Bit Rate (Gbps)	@Freq (GHz)	Ins. Loss (dB)
HDMI 1.4 (1080P)	2.25	1.13	-0.15
DisplayPort	2.70	1.35	-0.20
HDMI 1.4 (max spec)	3.40	1.70	-0.23
USB3.0	5.00	2.50	-0.29
eSATA	6.00	3.00	-0.35
Thunderbolt	10.0	5.00	-0.50

**Single Channel  
Silicon ESD Protector  
Overvoltage Protection Device**

**FIGURE 2. DEVICE IV CURVE**

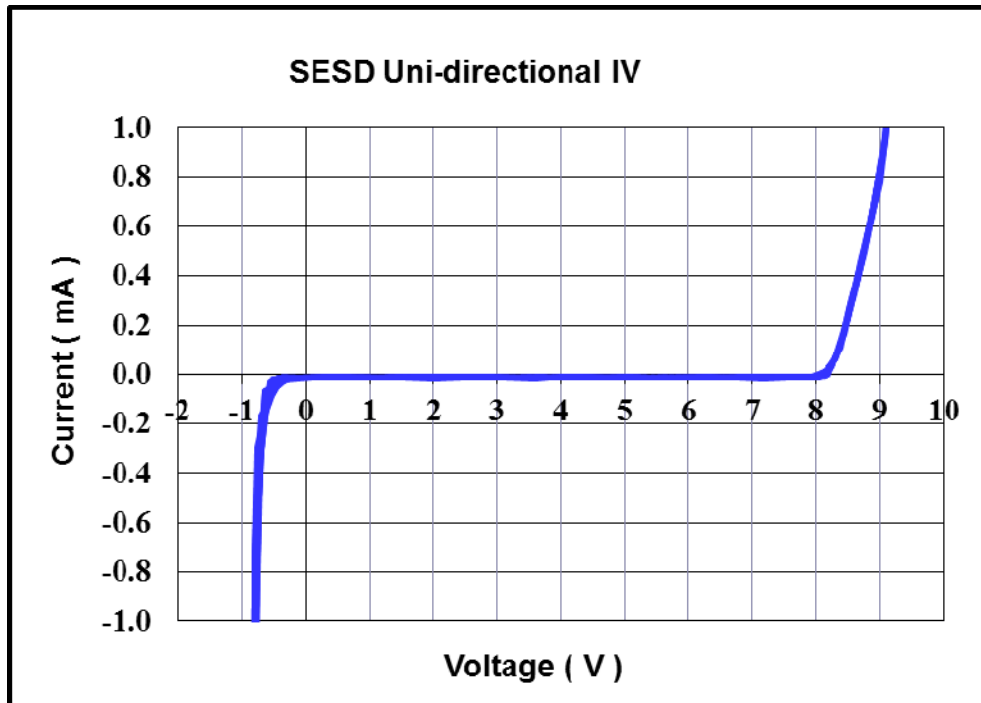

**FIGURE 3. ESD WITHSTAND**

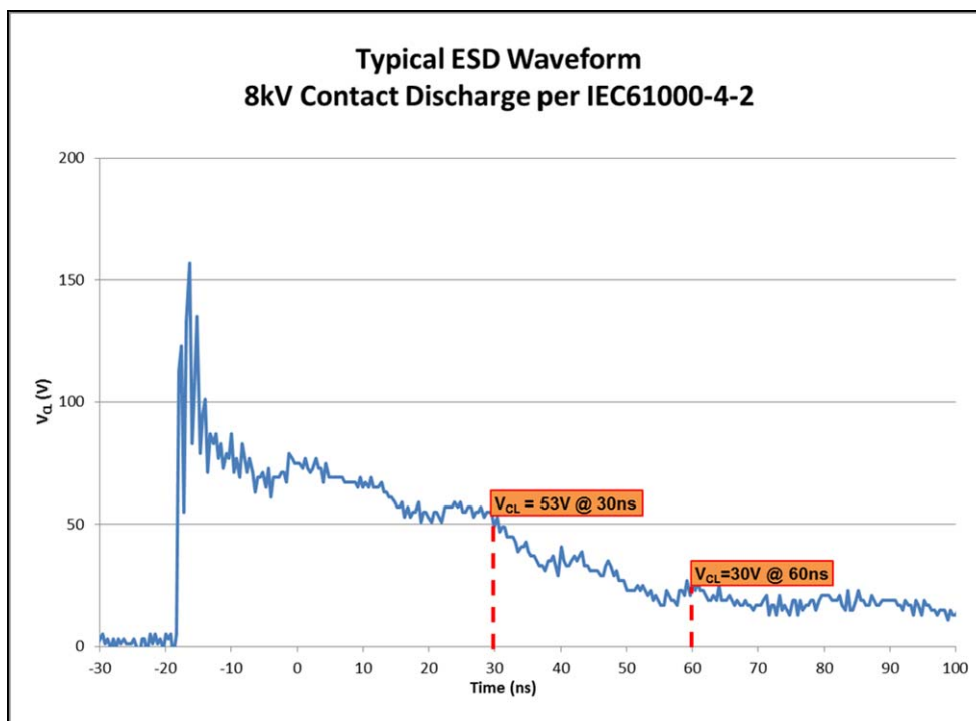

# Single Channel Silicon ESD Protector Overvoltage Protection Device

**PRODUCT: SESD0402X1UN-0020-090**

DOCUMENT: SCD28186  
REV LETTER: A  
REV DATE: December 6, 2011  
PAGE NO.: Page 4 of 6

## DEVICE DIMENSIONS

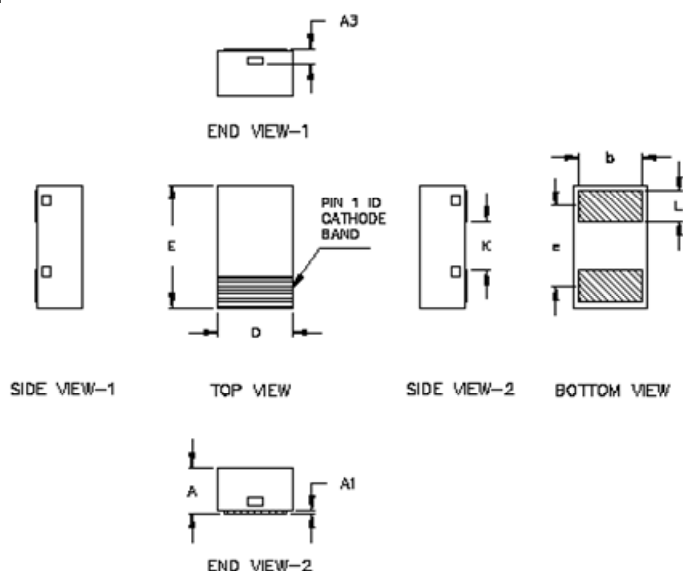

SESD0402X1UN-0020-090						
Dim	Mimeters (mm)			Inches (in)		
	Min	Nom	Max	Min	Nom	Max
A	0.33	0.38	0.43	0.0130	0.0150	0.0170
A1	0	-	0.05	0	-	0.0020
A3	0.130 ref.			0.005 ref.		
D	0.550	0.600	0.650	0.0220	0.0240	0.0260
E	0.950	1.000	1.050	0.0370	0.0390	0.0410
K	0.350	0.400	0.450	0.0140	0.0160	0.0180
b	0.450	0.500	0.550	0.0180	0.0200	0.0220
L	0.200	0.250	0.300	0.0080	0.0100	0.0120
e	0.650 BSC			0.026 BSC		

BSC – Basic Spacing between Centers

## RECOMMENDED LANDING PATTERN:

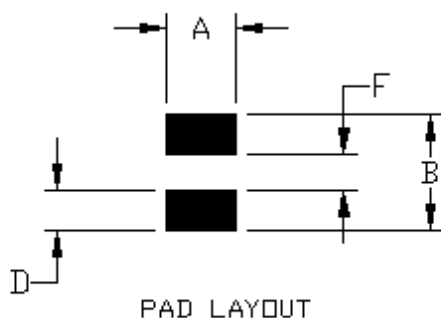

SESD Landing Pad Layout 0402 Package		
Symbol	Milimeters (mm)	Inches (in)
A	0.60	0.024
B	1.00	0.039
D	0.35	0.014
F	0.30	0.012

## PACKAGING

Packaging	Tape & Reel	Standard Box
SESD0402X1UN-0020-090	10,000	50,000

# Single Channel Silicon ESD Protector Overvoltage Protection Device

DOCUMENT: SCD28186  
REV LETTER: A  
REV DATE: December 6, 2011  
PAGE NO.: Page 5 of 6

## REEL DIMENSIONS

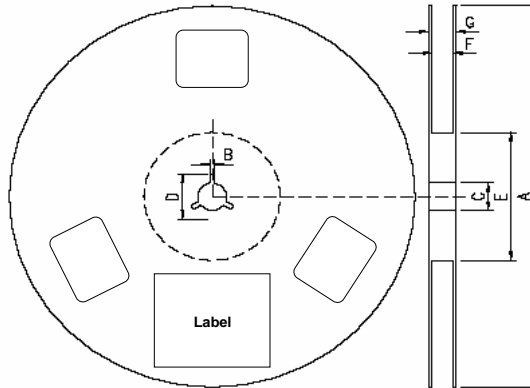

Dimensions	A	B	C	D	E	F	G
(mm)	180.0 ± 1.5	2.3. 0 ± 0.2	13.0 + 0.5 / -0.2	17.3 ± 0.2	60.5 ± 1.5	8.4 +1.5/-0.0	14.4 (max)

## CARRIER TAPE DIMENSIONS

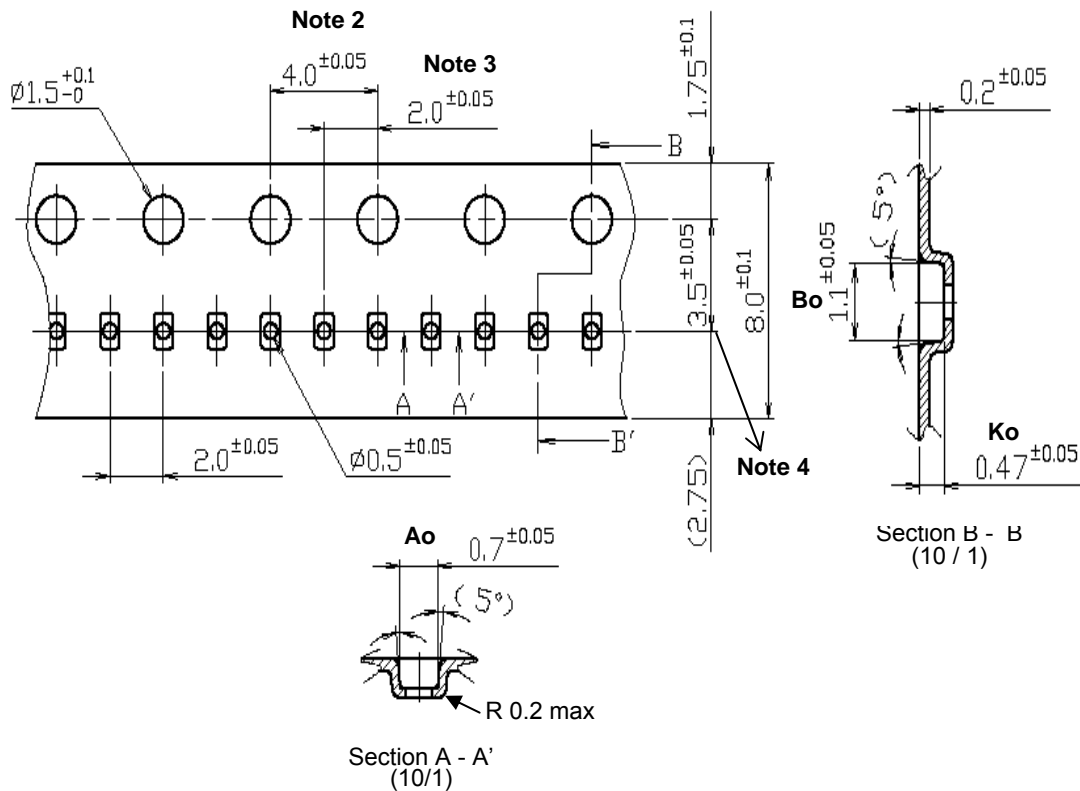

Ao	0.07 ± 0.05
Bo	1.1 ± 0.05
Ko	0.47 ± 0.05

Note 1. All dimensions in mm  
Note 2. Cumulative tolerance is 200 ± 0.3 / 50MM pitch  
Note 3. Center point of hole tolerance is 2.0 ± 0.5  
Note 4. Center point of hole tolerance is 3.5 ± 0.5

## Single Channel Silicon ESD Protector Overvoltage Protection Device

### SOLDER REFLOW RECOMMENDATION

A	Temperature ramp up 1	From ambient to Preheating temperature	30s to 60s
B	Preheating	140°C - 160°C	60s to 120s
C	Temperature ramp up 2	From Preheating to Main heating temperature	20s to 40s
D	Main heating	at 200°C at 220°C at 240°C at 260°C	60s ~ 70s 50s ~ 60s 30s ~ 40s 5s ~ 10s
E	Cooling	From main heating temperature to 100°C	4°C/s (max)

### FIGURE 4. REFLOW PROFILE

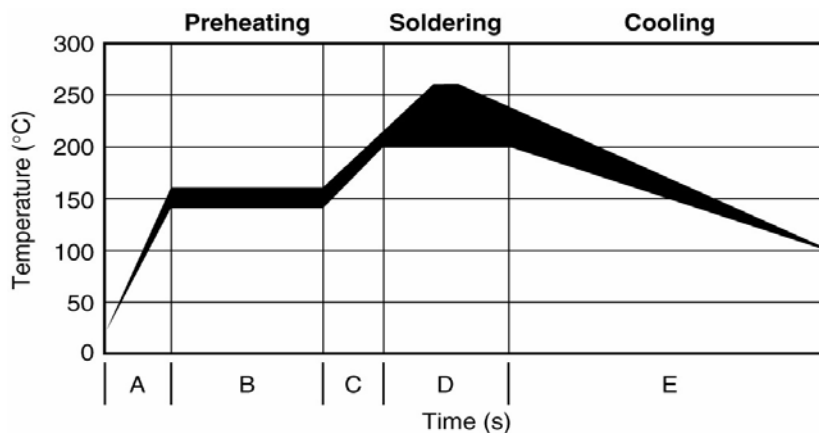

All information, including illustrations, is believed to be accurate and reliable. Users, however, should independently evaluate the suitability of and test each product selected for their application. Tyco Electronics Corporation and/or its Affiliates in the TE Connectivity Ltd. family of companies ("TE") make no warranties as to the accuracy or completeness of the information, and disclaims any liability regarding its use. TE only obligations are those in the TE Standard Terms and Conditions of Sale and in no case will TE be liable for any incidental, indirect, or consequential damages arising from the sale, resale, use, or misuse of its products. Specifications are subject to change without notice. In addition, TE reserves the right to make changes to materials or processing that do not affect compliance with any applicable specification without notification to Buyer. Without expressed or written consent by an officer of TE, TE does not authorize the use of any of its products as components in nuclear facility applications, aerospace, or in critical life support devices or systems.

**TE Connectivity, TE Connectivity (logo), and TE (logo)** are trademarks.

Other logos, products and /or company names might be trademarks of their respective owners.