



Is Now Part of



**ON Semiconductor®**

To learn more about ON Semiconductor, please visit our website at  
[www.onsemi.com](http://www.onsemi.com)

ON Semiconductor and the ON Semiconductor logo are trademarks of Semiconductor Components Industries, LLC dba ON Semiconductor or its subsidiaries in the United States and/or other countries. ON Semiconductor owns the rights to a number of patents, trademarks, copyrights, trade secrets, and other intellectual property. A listing of ON Semiconductor's product/patent coverage may be accessed at [www.onsemi.com/site/pdf/Patent-Marking.pdf](http://www.onsemi.com/site/pdf/Patent-Marking.pdf). ON Semiconductor reserves the right to make changes without further notice to any products herein. ON Semiconductor makes no warranty, representation or guarantee regarding the suitability of its products for any particular purpose, nor does ON Semiconductor assume any liability arising out of the application or use of any product or circuit, and specifically disclaims any and all liability, including without limitation special, consequential or incidental damages. Buyer is responsible for its products and applications using ON Semiconductor products, including compliance with all laws, regulations and safety requirements or standards, regardless of any support or applications information provided by ON Semiconductor. "Typical" parameters which may be provided in ON Semiconductor data sheets and/or specifications can and do vary in different applications and actual performance may vary over time. All operating parameters, including "Typicals" must be validated for each customer application by customer's technical experts. ON Semiconductor does not convey any license under its patent rights nor the rights of others. ON Semiconductor products are not designed, intended, or authorized for use as a critical component in life support systems or any FDA Class 3 medical devices or medical devices with a same or similar classification in a foreign jurisdiction or any devices intended for implantation in the human body. Should Buyer purchase or use ON Semiconductor products for any such unintended or unauthorized application, Buyer shall indemnify and hold ON Semiconductor and its officers, employees, subsidiaries, affiliates, and distributors harmless against all claims, costs, damages, and expenses, and reasonable attorney fees arising out of, directly or indirectly, any claim of personal injury or death associated with such unintended or unauthorized use, even if such claim alleges that ON Semiconductor was negligent regarding the design or manufacture of the part. ON Semiconductor is an Equal Opportunity/Affirmative Action Employer. This literature is subject to all applicable copyright laws and is not for resale in any manner.



# FAN2013B — 2A Low-Voltage, Current-Mode Synchronous PWM Buck Regulator

## Features

- 95% Efficiency, Synchronous Operation
- Adjustable Output Voltage from 0.8V to 2.5V
- 4.5V to 5.5V Input Voltage Range
- Up to 2A Output Current
- Fixed-Frequency 1.2 MHz PWM Operation
- Soft-Start Function
- Excellent Load Transient Response
- Power-Good Flag
- Over-Voltage, Under-Voltage Lockout, Short-Circuit, and Thermal Shutdown Protections
- 3x3mm 6-Lead MLP Package

## Applications

- Hard Disk Drive
- Set-Top Box
- Point-of-Load Power
- Notebook Computer
- Communications Equipment

## Description

The FAN2013B is a high-efficiency, low-noise, synchronous Pulse Width Modulated (PWM) current-mode DC-DC converter designed for low-voltage applications. It provides up to 2A continuous-load current from the 4.5V to 5.5V input. The output voltage is adjustable over a wide range by means of an external voltage divider.

The FAN2013B is enabled when the input voltage on the  $V_{IN}$  pin exceeds the UVLO threshold.

A current-mode control loop with a fast transient response ensures excellent line and load regulation. The fixed 1.2MHz switching frequency enables designers to choose a small, inexpensive external inductor and capacitor. Filtering can be accomplished with small components, reducing space and cost.

Protection features include input under-voltage lockout, short-circuit protection, and thermal shutdown. Soft-start limits inrush current during start-up conditions.

The device is available in a 3x3mm 6-lead MLP.

## Typical Application

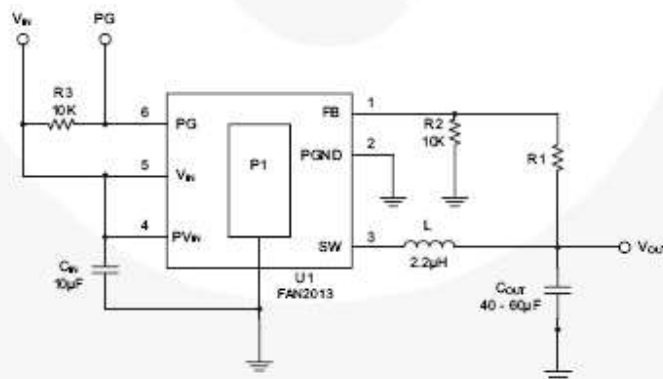

Figure 1. Typical Application

## Ordering Information

Part Number	Output Voltage	Package	Packing Method
FAN2013BMPX	0.8V to 2.5V	3x3mm 6-Lead Molded Leadless Package (MLP)	Tape and Reel

## Pin Assignments

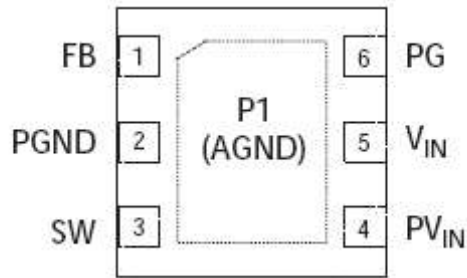

Figure 2. Pin Assignments (Top View)

## Pin Definitions

Pin #	Name	Description
P1	AGND	<b>Analog Ground.</b> P1 must be soldered to the PCB ground.
1	FB	<b>Feedback Input.</b> Adjustable voltage option; connect this pin to the resistor divider.
2	PGND	<b>Power Ground.</b> This pin is connected to the internal MOSFET switches. This pin must be externally connected to AGND.
3	SW	<b>Switching Node.</b> This pin is connected to the internal MOSFET switches.
4	PVIN	<b>Supply Voltage Input.</b> This pin is connected to the internal MOSFET switches.
5	VIN	<b>Supply Voltage Input.</b>
6	PG	<b>Open Drain Power Good.</b>

## Absolute Maximum Ratings

Stresses exceeding the absolute maximum ratings may damage the device. The device may not function or be operable above the recommended operating conditions and stressing the parts to these levels is not recommended. In addition, extended exposure to stresses above the recommended operating conditions may affect device reliability. The absolute maximum ratings are stress ratings only.

Symbol	Parameter	Min.	Max.	Unit
$V_{IN}$	Supply Voltage	-0.3	7.0	V
	Input Voltage on PVIN and Any Other Pin	-0.3	$V_{IN}$	V
$\theta_{JC}$	Thermal Resistance, Junction-to-Tab <sup>(1)</sup>		8	°C/W
$T_L$	Lead Soldering Temperature (10 Seconds)		+260	°C
$T_{STG}$	Storage Temperature	-65	+150	°C
$T_J$	Junction Temperature	-40	+150	°C
ESD	Electrostatic Discharge Protection Level <sup>(2)</sup>	Human Body Model, JESD22-A114	3.5	kV
		Charged Device Model, JESD22-C101	2.0	

### Notes:

- Junction-to-ambient thermal resistance,  $\theta_{JA}$ , is a strong function of PCB material, board thickness, thickness and number of copper planes, number of via used, diameter of via used, available copper surface, and attached heat sink characteristics.
- Using Mil Std. 883E, method 3015.7 (Human Body Model) and EIA/JESD22C101-A (Charged Device Model).

## Recommended Operating Conditions

The Recommended Operating Conditions table defines the conditions for actual device operation. Recommended operating conditions are specified to ensure optimal performance to the datasheet specifications. Fairchild does not recommend exceeding them or designing to Absolute Maximum Ratings.

Symbols	Parameter	Min.	Typ.	Max.	Unit
$V_{IN}$	Supply Voltage Range	4.5		5.5	V
$V_{OUT}$	Output Voltage Range, Adjustable Version	0.8		2.5	V
$I_{OUT}$	Output Current			2.0	A
L	Inductor <sup>(3)</sup>		2.2		μH
$C_{IN}$	Input Capacitor <sup>(3)</sup>	10	20		μF
$C_{OUT}$	Output Capacitor <sup>(3)</sup>	20	40		μF
$T_A$	Operating Ambient Temperature Range	-40		+85	°C

### Note:

- Refer to the Applications section for details.

## Electrical Characteristics

$V_{IN} = 4.5V$  to  $5.5V$ ,  $V_{OUT} = 1.2V$ ,  $I_{OUT} = 200mA$ ,  $C_{IN} = 10\mu F$ ,  $C_{OUT} = 40\mu F$ ,  $L = 2.2\mu H$ ,  $T_A = -40^\circ C$  to  $+85^\circ C$ , unless otherwise noted. Typical values are at  $T_A = 25^\circ C$ .

Symbol	Parameter	Conditions	Min.	Typ.	Max.	Units
$V_{IN}$	Input Voltage		4.5		5.5	V
$I_Q$	Quiescent Current	$I_{OUT} = 0mA$		10	16	mA
$V_{UVLO}$	UVLO Threshold	$V_{IN}$ Rising	3.4	3.7	4.0	V
		Hysteresis		150		mV
$R_{ON\_PMOS}$	PMOS On Resistance	$V_{IN} = V_{GS} = 5V$		90		m $\Omega$
$R_{ON\_NMOS}$	NMOS On Resistance	$V_{IN} = V_{GS} = 5V$		90		m $\Omega$
$I_{LIMIT}$	P-Channel Current Limit	$4.5V < V_{IN} < 5.5V$	2.8	3.5	4.2	A
	Over-Temperature Protection	Rising Temperature		150		$^\circ C$
		Hysteresis		20		$^\circ C$
$f_{SW}$	Switching Frequency		1000	1200	1400	kHz
$R_{LINE}$	Line Regulation	$V_{IN} = 4.5$ to $5.5V$ , $I_{OUT} = 100mA$		0.16		%/V
$R_{LOAD}$	Load Regulation	$0mA \leq I_{OUT} \leq 2000mA$		0.3	0.6	%
$V_{OUT}$	Output Voltage During Load Transition <sup>(4)</sup>	$I_{OUT}$ from 1500mA to 100mA, $C_{OUT} = 60\mu F$			5	%
		$I_{OUT}$ from 100mA to 1500mA, $C_{OUT} = 60\mu F$	-5			%
$I_{LEAK}$	Reverse Leakage Current into Pin SW	$V_{IN} = \text{Open}$ , $EN = GND$ , $V_{SW} = 5.5V$		0.1	1.0	$\mu A$
$V_{REF}$	Reference Voltage			0.8		V
$V_{OUT}$	Output Voltage Accuracy	$V_{IN} = 4.5$ to $5.5V$ , $0mA \leq I_{OUT} \leq 2000mA$ , $T_A = 0^\circ C$ to $+85^\circ C$	-2		2	%
		$V_{IN} = 4.5$ to $5.5V$ , $0mA \leq I_{OUT} \leq 2000mA$ , $T_A = -40^\circ C$ to $+85^\circ C$	-3		3	%
$V_{PG}$	Power Good Output Threshold and Hysteresis	FB Voltage Rising		$0.9 \times V_{OUT}$		V
		Hysteresis		1		%
$t_{PG}$	Power Good Output Delay			100		$\mu s$
$V_{PG\_LOW}$	Power Good Voltage Low	$I_{sink} = 6mA$ , Open-Drain Output			0.4	V
$V_{OVP}$	Over-Voltage Protection Threshold and Hysteresis	FB Voltage Rising		$1.07 \times V_{OUT}$		V
		Hysteresis		2		%

**Note:**

4. Please refer to the load transient response test waveform shown in Figure 3.

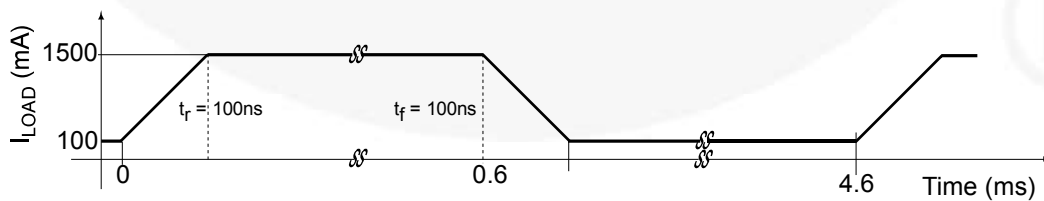

**Figure 3. Load Transient Response Test Waveform**

## Typical Performance Characteristics

$T_A = 25^\circ\text{C}$ ,  $C_{IN} = 10\mu\text{F}$ ,  $C_{OUT} = 40\mu\text{F}$ ,  $L = 2.2\mu\text{H}$ ,  $V_{IN} = 5\text{V}$ ,  $V_{OUT} = 1.2\text{V}$ , unless otherwise noted.

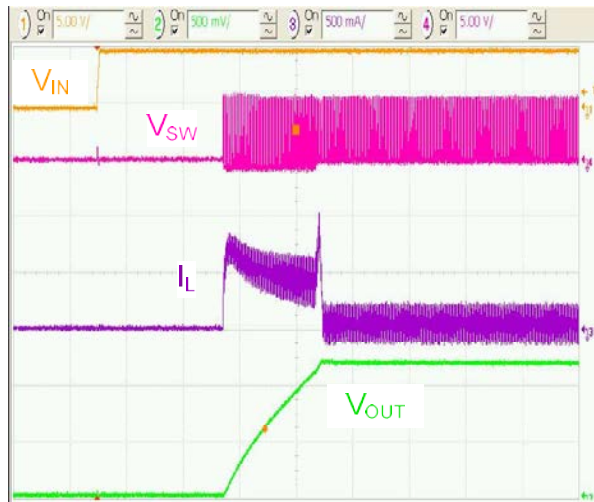

Figure 4. Startup with 100mA Resistive Load

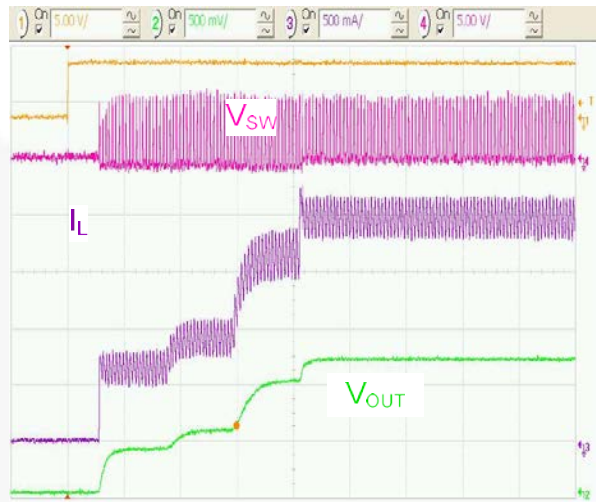

Figure 5. Startup with 2A Resistive Load

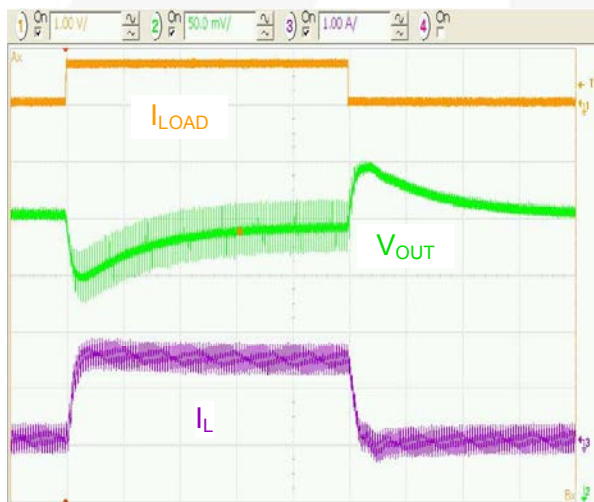

Figure 6. Load Transient Response, 1.2V<sub>OUT</sub> (100mA to 1500mA, 20μs/div)



Figure 7. Load Transient Response, 3.3V<sub>OUT</sub> (100mA to 1500mA, 20μs/div)

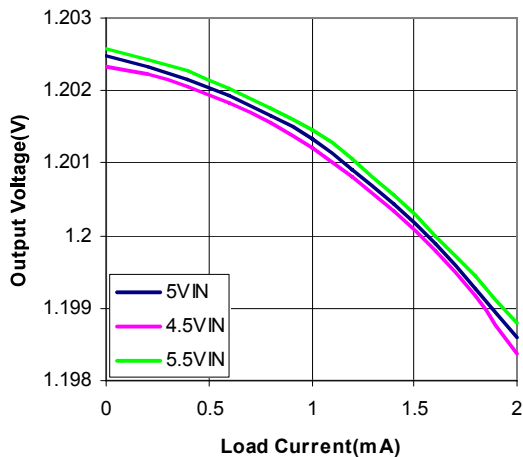

Figure 8. Output Voltage Regulation

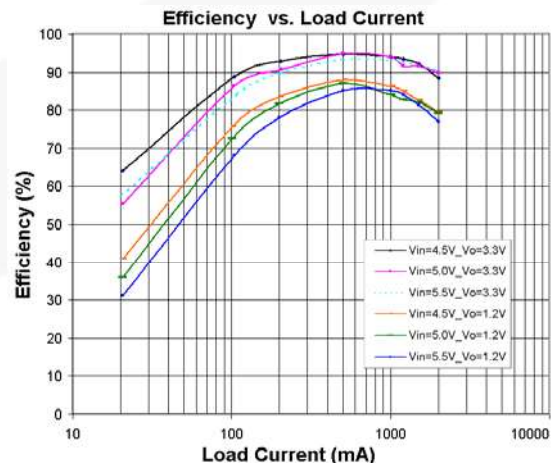

Figure 9. Power Efficiency

## Block Diagram

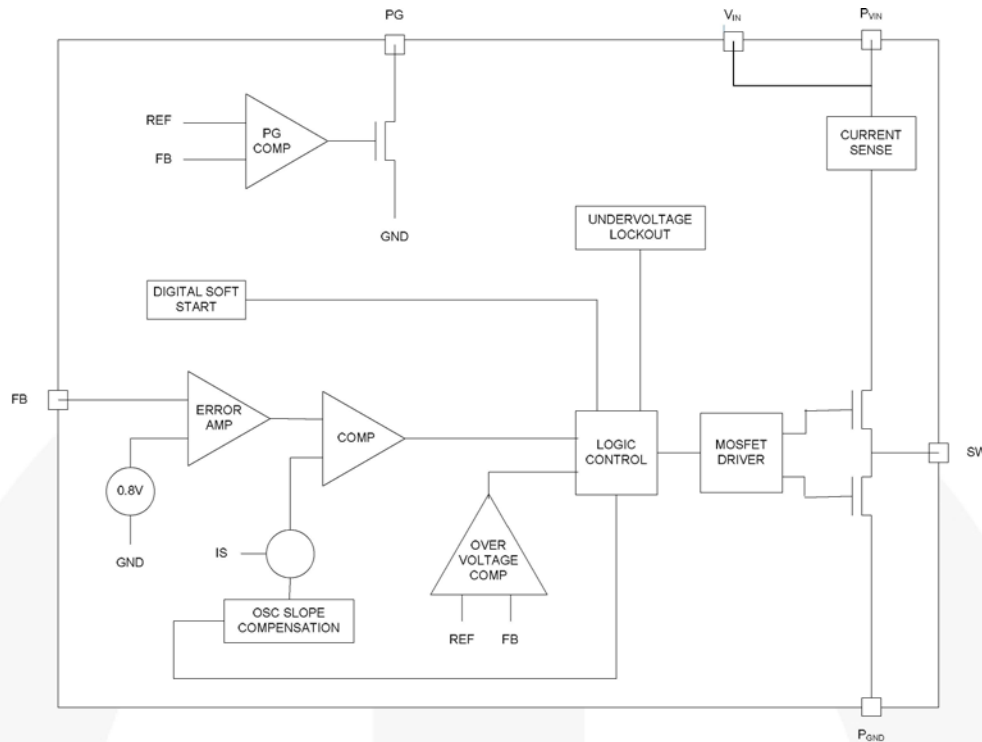

Figure 10. Block Diagram

## Detailed Operation Description

The FAN2013B is a step-down pulse-width modulated (PWM) current mode converter with a fixed switching frequency of 1.2MHz. At the rising edge of each clock cycle, the P-channel transistor is turned on until the PWM comparator trips or the current limit is reached. During the ON time, the inductor current ramps up and is monitored by the internal current-mode control loop. After a minimum dead time, the N-channel transistor is turned ON and the inductor current ramps down. As the clock cycle is completed, the N-channel switch is turned OFF and the next clock cycle starts. The duty cycle is given by the ratio of output voltage and input voltage. The converter runs at minimum duty cycle when the output voltage is at minimum and input voltage is at maximum. The duty cycle increases proportionally as the input voltage approaches the output voltage.

### UVLO and Soft-Start

The internal voltage reference,  $V_{REF}$ , and the IC remain reset until  $V_{IN}$  reaches the UVLO threshold.

The FAN2013B has an internal soft-start circuit that limits the inrush current during start-up. This prevents possible voltage drops of the input voltage and eliminates the output voltage overshoot. The soft-start is implemented as a digital circuit, increasing the switch current in four steps to the P-channel current limit. Typical start-up time for a 40 $\mu$ F output capacitor with a load current of 2.0A is 800 $\mu$ s.

### Output Over-Voltage Protection

When output voltage,  $V_{OUT}$ , reaches approximately 7% above the nominal value, the device turns OFF the P-channel switch and turns ON part of the N-channel transistor with a built-in current limit of about 400mA. When  $V_{OUT}$  reaches the hysteresis of about 2%, the device starts switching normally in closed loop. If output voltage is pulled up by an external voltage source with a current limit higher than typical 400mA, the output voltage stays up at the external voltage source level.

The over-voltage protection is designed to limit the output voltage excursion in case of a transient response from full load to a minimum load.

### Output Short-Circuit Protection

The switch peak current is limited cycle by cycle to a typical value of 3.5A. In the event of an output voltage short circuit, the device operates with a frequency of 400kHz and minimum duty cycle, making the average typical input current 0.45A.

### Thermal Shutdown

When the die temperature exceeds 150°C, a reset occurs and remains in effect until the die cools to 130°C, when the circuit is allowed to re-initiate a soft-start cycle..

## Applications Information

### Setting the Output Voltage

The internal voltage reference is 0.8V. The output is divided down by a voltage divider, R1 and R2 to the FB pin. The output voltage is:

$$V_{OUT} = V_{REF} \left( 1 + \frac{R_1}{R_2} \right) \quad (2)$$

According to this equation, assuming desired output voltage of 1.2V, and given R2 = 10KΩ as the recommended resistance for any output voltage setting, the calculated value of R1 is 5KΩ. Maximum V<sub>OUT</sub> = 2.5V.

### Inductor Selection

The inductor parameters directly related to device performance are saturation current and DC resistance. The FAN2013B operates with a typical inductor value of 2.2μH. The lower the DC resistance, the higher the efficiency. For saturation current, the inductor should be rated higher than the maximum load current, plus half of the inductor ripple current, calculated by:

$$\Delta I_L = V_{OUT} \times \frac{1 - (V_{OUT}/V_{IN})}{L \times f} \quad (3)$$

where:

ΔI<sub>L</sub> = Inductor Ripple Current  
 f = Switching Frequency  
 L = Inductor Value

Recommended inductors are listed in Table 1.

**Table 1. Recommended Inductors**

Inductor Value	Vendor	Part Number
2.2μH	Coiltronics	SD25 2R2
2.2μH	Murata	LQH66SN2R2M03L

### Capacitor Selection

For best performance, a low-ESR input capacitor is required. A ceramic capacitor of at least 10μF, placed as close to the V<sub>IN</sub> and AGND pins as possible is recommended.

The output capacitor determines the output ripple and the transient response. A minimum of 20μF output capacitor is required for the FAN2013B to operate in stable conditions.

**Table 2. Recommended Capacitors**

Capacitor Value	Vendor	Part Number
10μF	Taiyo Yuden	JMK212BJ106MG
		JMK316BJ106KL
	TDK	C2012X5ROJ106K
		C3216X5ROJ106M
	Murata	GRM32ER61C106K

### PCB Layout Recommendations

The inherently high peak currents and switching frequency of power supplies require a careful PCB layout design. For best results, use wide traces for high-current paths and place the input capacitor, the inductor, and the output capacitor as close as possible to the integrated circuit terminals. To minimize voltage stress to the device resulting from ever-present switching spikes, use an input bypass capacitor with low ESR. Note that the peak amplitude of the switching spikes depends upon the load current; the higher the load current, the higher the switching spikes.

The resistor divider that sets the output voltage should be routed away from the inductor to avoid RF coupling. The ground plane at the bottom side of the PCB acts as an electromagnetic shield to reduce EMI. The recommended PCB layout is shown below in Figure 11.

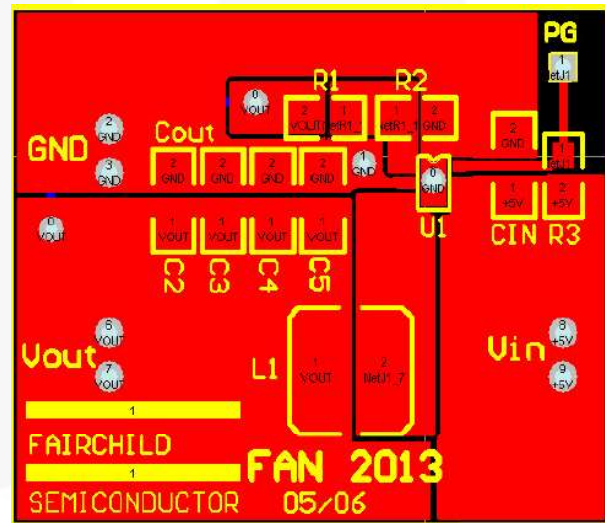

**Figure 11. Recommended PCB Layout**



## Physical Dimensions

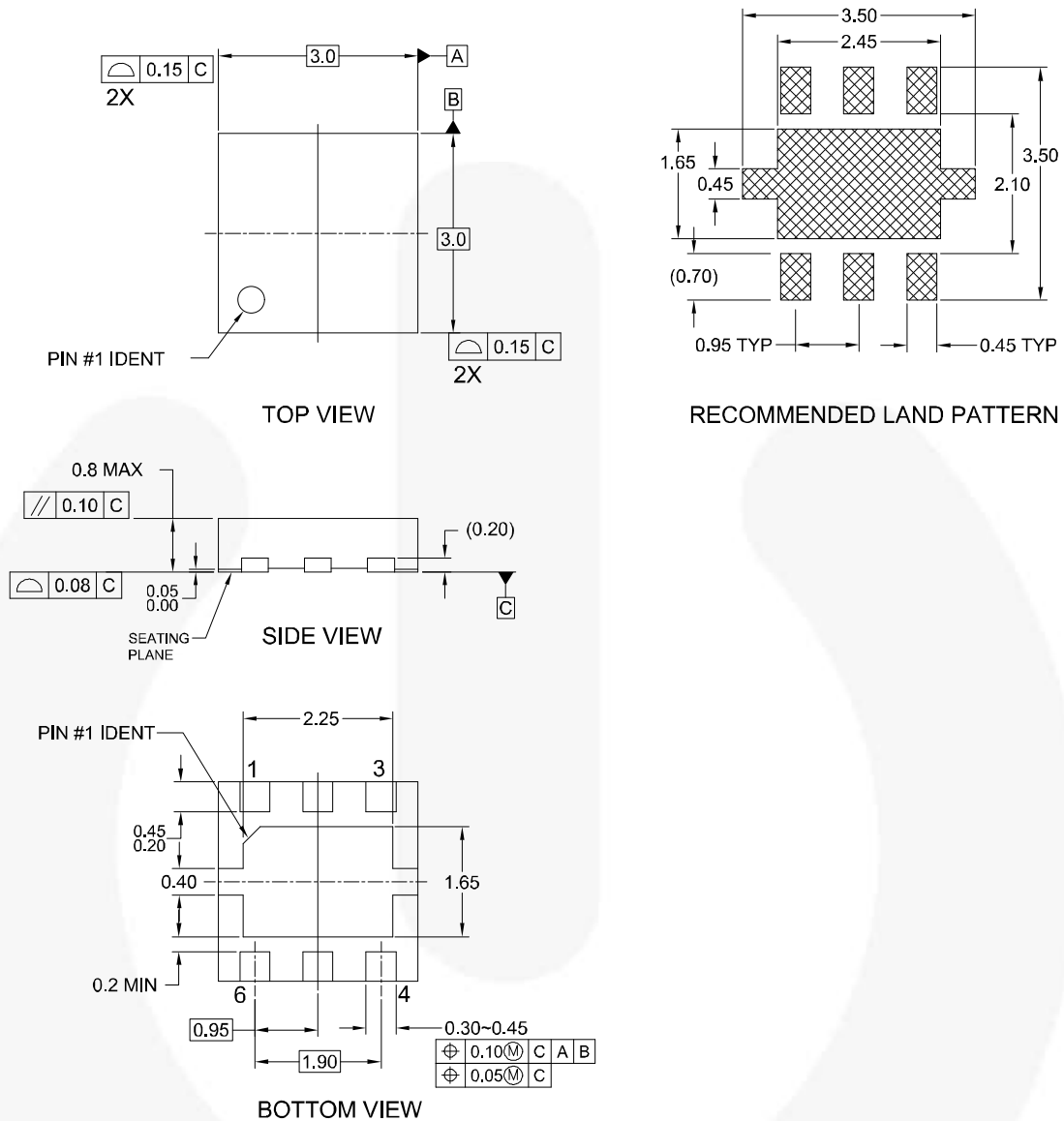

### NOTES:

- A. CONFORMS TO JEDEC REGISTRATION MO-229, VARIATION WEEA, DATED 11/2001 EXCEPT FOR DAP EXTENSION TABS
- B. DIMENSIONS ARE IN MILLIMETERS.
- C. DIMENSIONS AND TOLERANCES PER ASME Y14.5M, 1994

MLP06FrevA

**Figure 12. 3x3mm 6-Lead Molded Leadless Package (MLP)**





Package drawings are provided as a service to customers considering Fairchild components. Drawings may change in any manner without notice. Please note the revision and/or date on the drawing and contact a Fairchild Semiconductor representative to verify or obtain the most recent revision. Package specifications do not expand the terms of Fairchild's worldwide terms and conditions, specifically the warranty therein, which covers Fairchild products.

Always visit Fairchild Semiconductor's online packaging area for the most recent package drawings:  
<http://www.fairchildsemi.com/packaging/>



**TRADEMARKS**

The following includes registered and unregistered trademarks and service marks, owned by Fairchild Semiconductor and/or its global subsidiaries, and is not intended to be an exhaustive list of all such trademarks.

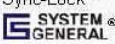
- |                                                                                              |                                                                                            |                                                                                                   |                                                                                             |
|----------------------------------------------------------------------------------------------|--------------------------------------------------------------------------------------------|---------------------------------------------------------------------------------------------------|---------------------------------------------------------------------------------------------|
| AccuPower™                                                                                   | F-PFS™                                                                                     | Power-SPM™                                                                                        | The Power Franchise®                                                                        |
| Auto-SPM™                                                                                    | FRFET®                                                                                     | PowerTrench®                                                                                      | The Right Technology for Your Success™                                                      |
| AX-CAP™                                                                                      | Global Power Resource™                                                                     | PowerXS™                                                                                          | <b>the Power Franchise</b>                                                                  |
| Build it Now™                                                                                | Green FPST™                                                                                | Programmable Active Droop™                                                                        | TinyBoost™                                                                                  |
| CorePLUS™                                                                                    | Green FPST™ e-Series™                                                                      | QFET®                                                                                             | TinyBuck™                                                                                   |
| CorePOWER™                                                                                   | Gmax™                                                                                      | QST™                                                                                              | TinyCalc™                                                                                   |
| CROSSVOLT™                                                                                   | GTO™                                                                                       | Quiet Series™                                                                                     | TinyLogic®                                                                                  |
| CTL™                                                                                         | IntelliMAX™                                                                                | RapidConfigure™                                                                                   | TINYOPTO™                                                                                   |
| Current Transfer Logic™                                                                      | ISOPLANAR™                                                                                 |  ™               | TinyPower™                                                                                  |
| DEUXPEED®                                                                                    | MegaBuck™                                                                                  | Saving our world, 1mW/W/kW at a time™                                                             | TinyPWM™                                                                                    |
| Dual Cool™                                                                                   | MICROCOUPLER™                                                                              | SignalWise™                                                                                       | TinyWire™                                                                                   |
| EcoSPARK®                                                                                    | MicroFET™                                                                                  | SmartMax™                                                                                         | TriFault Detect™                                                                            |
| EfficientMax™                                                                                | MicroPak™                                                                                  | SMART START™                                                                                      | TRUECURRENT™*                                                                               |
| ESBC™                                                                                        | MicroPak2™                                                                                 | SPM®                                                                                              | µSerDes™                                                                                    |
|  Fairchild® | MillerDrive™                                                                               | STEALTH™                                                                                          |  SerDes® |
| Fairchild Semiconductor®                                                                     | MotionMax™                                                                                 | SuperFET®                                                                                         | UHC®                                                                                        |
| FACT Quiet Series™                                                                           | Motion-SPM™                                                                                | SuperSOT™.3                                                                                       | Ultra FRFET™                                                                                |
| FACT®                                                                                        | mWSaver™                                                                                   | SuperSOT™.6                                                                                       | UniFET™                                                                                     |
| FAST®                                                                                        | OptoHiT™                                                                                   | SuperSOT™.8                                                                                       | VCX™                                                                                        |
| FastvCore™                                                                                   | OPTOLOGIC®                                                                                 | SupreMOS®                                                                                         | VisualMax™                                                                                  |
| FETBench™                                                                                    | OPTOPLANAR®                                                                                | SyncFET™                                                                                          | XST™                                                                                        |
| FlashWriter®                                                                                 |  PDP SPM™ | Sync-Lock™                                                                                        |                                                                                             |
| FPST™                                                                                        |                                                                                            |  SYSTEM GENERAL® |                                                                                             |

\* Trademarks of System General Corporation, used under license by Fairchild Semiconductor.

**DISCLAIMER**

FAIRCHILD SEMICONDUCTOR RESERVES THE RIGHT TO MAKE CHANGES WITHOUT FURTHER NOTICE TO ANY PRODUCTS HEREIN TO IMPROVE RELIABILITY, FUNCTION, OR DESIGN. FAIRCHILD DOES NOT ASSUME ANY LIABILITY ARISING OUT OF THE APPLICATION OR USE OF ANY PRODUCT OR CIRCUIT DESCRIBED HEREIN; NEITHER DOES IT CONVEY ANY LICENSE UNDER ITS PATENT RIGHTS, NOR THE RIGHTS OF OTHERS. THESE SPECIFICATIONS DO NOT EXPAND THE TERMS OF FAIRCHILD'S WORLDWIDE TERMS AND CONDITIONS, SPECIFICALLY THE WARRANTY THEREIN, WHICH COVERS THESE PRODUCTS.

**LIFE SUPPORT POLICY**

FAIRCHILD'S PRODUCTS ARE NOT AUTHORIZED FOR USE AS CRITICAL COMPONENTS IN LIFE SUPPORT DEVICES OR SYSTEMS WITHOUT THE EXPRESS WRITTEN APPROVAL OF FAIRCHILD SEMICONDUCTOR CORPORATION.

As used herein:

- Life support devices or systems are devices or systems which, (a) are intended for surgical implant into the body or (b) support or sustain life, and (c) whose failure to perform when properly used in accordance with instructions for use provided in the labeling, can be reasonably expected to result in a significant injury of the user.
- A critical component in any component of a life support, device, or system whose failure to perform can be reasonably expected to cause the failure of the life support device or system, or to affect its safety or effectiveness.

**ANTI-COUNTERFEITING POLICY**

Fairchild Semiconductor Corporation's Anti-Counterfeiting Policy. Fairchild's Anti-Counterfeiting Policy is also stated on our external website, [www.fairchildsemi.com](http://www.fairchildsemi.com), under Sales Support.

Counterfeiting of semiconductor parts is a growing problem in the industry. All manufacturers of semiconductor products are experiencing counterfeiting of their parts. Customers who inadvertently purchase counterfeit parts experience many problems such as loss of brand reputation, substandard performance, failed applications, and increased cost of production and manufacturing delays. Fairchild is taking strong measures to protect ourselves and our customers from the proliferation of counterfeit parts. Fairchild strongly encourages customers to purchase Fairchild parts either directly from Fairchild or from Authorized Fairchild Distributors who are listed by country on our web page cited above. Products customers buy either from Fairchild directly or from Authorized Fairchild Distributors are genuine parts, have full traceability, meet Fairchild's quality standards for handling and storage and provide access to Fairchild's full range of up-to-date technical and product information. Fairchild and our Authorized Distributors will stand behind all warranties and will appropriately address any warranty issues that may arise. Fairchild will not provide any warranty coverage or other assistance for parts bought from Unauthorized Sources. Fairchild is committed to combat this global problem and encourage our customers to do their part in stopping this practice by buying direct or from authorized distributors.

**PRODUCT STATUS DEFINITIONS**

**Definition of Terms**

Datasheet Identification	Product Status	Definition
Advance Information	Formative / In Design	Datasheet contains the design specifications for product development. Specifications may change in any manner without notice.
Preliminary	First Production	Datasheet contains preliminary data; supplementary data will be published at a later date. Fairchild Semiconductor reserves the right to make changes at any time without notice to improve design.
No Identification Needed	Full Production	Datasheet contains final specifications. Fairchild Semiconductor reserves the right to make changes at any time without notice to improve the design.
Obsolete	Not In Production	Datasheet contains specifications on a product that is discontinued by Fairchild Semiconductor. The datasheet is for reference information only.

Rev. I52

ON Semiconductor and  are trademarks of Semiconductor Components Industries, LLC dba ON Semiconductor or its subsidiaries in the United States and/or other countries. ON Semiconductor owns the rights to a number of patents, trademarks, copyrights, trade secrets, and other intellectual property. A listing of ON Semiconductor's product/patent coverage may be accessed at [www.onsemi.com/site/pdf/Patent-Marking.pdf](http://www.onsemi.com/site/pdf/Patent-Marking.pdf). ON Semiconductor reserves the right to make changes without further notice to any products herein. ON Semiconductor makes no warranty, representation or guarantee regarding the suitability of its products for any particular purpose, nor does ON Semiconductor assume any liability arising out of the application or use of any product or circuit, and specifically disclaims any and all liability, including without limitation special, consequential or incidental damages. Buyer is responsible for its products and applications using ON Semiconductor products, including compliance with all laws, regulations and safety requirements or standards, regardless of any support or applications information provided by ON Semiconductor. "Typical" parameters which may be provided in ON Semiconductor data sheets and/or specifications can and do vary in different applications and actual performance may vary over time. All operating parameters, including "Typicals" must be validated for each customer application by customer's technical experts. ON Semiconductor does not convey any license under its patent rights nor the rights of others. ON Semiconductor products are not designed, intended, or authorized for use as a critical component in life support systems or any FDA Class 3 medical devices or medical devices with a same or similar classification in a foreign jurisdiction or any devices intended for implantation in the human body. Should Buyer purchase or use ON Semiconductor products for any such unintended or unauthorized application, Buyer shall indemnify and hold ON Semiconductor and its officers, employees, subsidiaries, affiliates, and distributors harmless against all claims, costs, damages, and expenses, and reasonable attorney fees arising out of, directly or indirectly, any claim of personal injury or death associated with such unintended or unauthorized use, even if such claim alleges that ON Semiconductor was negligent regarding the design or manufacture of the part. ON Semiconductor is an Equal Opportunity/Affirmative Action Employer. This literature is subject to all applicable copyright laws and is not for resale in any manner.

## PUBLICATION ORDERING INFORMATION

### LITERATURE FULFILLMENT:

Literature Distribution Center for ON Semiconductor  
19521 E. 32nd Pkwy, Aurora, Colorado 80011 USA  
**Phone:** 303-675-2175 or 800-344-3860 Toll Free USA/Canada  
**Fax:** 303-675-2176 or 800-344-3867 Toll Free USA/Canada  
**Email:** [orderlit@onsemi.com](mailto:orderlit@onsemi.com)

**N. American Technical Support:** 800-282-9855 Toll Free  
USA/Canada  
**Europe, Middle East and Africa Technical Support:**  
Phone: 421 33 790 2910  
**Japan Customer Focus Center**  
Phone: 81-3-5817-1050

**ON Semiconductor Website:** [www.onsemi.com](http://www.onsemi.com)  
**Order Literature:** <http://www.onsemi.com/orderlit>  
For additional information, please contact your local  
Sales Representative